

Operating, Maintenance & Parts Manual

VALUSTAR™



Rated Loads
1/4 through 2-Tons
250 through 2000 kg.

Follow all instructions and warnings for inspecting, maintaining and operating this hoist.

The use of any hoist presents some risk of personal injury or property damage. That risk is greatly increased if proper instructions and warnings are not followed. Before using this hoist, each operator should become thoroughly familiar with all warnings, instructions, and recommendations in this manual. **Retain this manual for future reference and use.**

Forward this manual to the hoist operator. Failure to operate the equipment as directed in the manual may cause injury.

Before using the hoist, fill in the information below. Refer to the hoist identification plate.

Model Number _____

Serial Number _____

Purchase Date _____

Voltage _____

Rated Load _____



CM HOIST PARTS AND SERVICES ARE AVAILABLE IN THE UNITED STATES AND IN CANADA

As a CM Hoist user, you are assured of reliable repair and parts services through a network of Master Parts Depots and Service Centers that are strategically located in the United States and Canada. These facilities have been selected on the basis of their demonstrated ability to handle all parts and repair requirements promptly and efficiently.

Below is a list of the Master Parts Depots in the United States and Canada. To quickly obtain the name of the U.S. Service Center located nearest you, call (800) 888-0985. Fax: (716) 689-5644. In the following list, the Canadian Service Centers are indicated.

UNITED STATES MASTER PARTS DEPOT

CALIFORNIA

OTTO SYSTEMS, INC.
12010 Bloomfield Ave.
Santa Fe Springs, CA 90670
562/462-1612 or 800/596-7392
Fax 562/462-1617
or
7656 Las Positas Road
Livermore, CA 94551
925/245-8800 or 800/508-6886
Fax 925/245-8804

COLORADO

MATERIALS HANDLING EQUIPMENT CO.
1740 W. 13th Ave.
Denver, CO 80204
303/573-5333
Fax 303/893-3854

GEORGIA

ACE INDUSTRIES, INC.
6295 McDonough Drive
Norcross, GA 30093
770/441-0898 or 800-733-2231
Fax 800/628-3648

ILLINOIS

JOHN SAKASH COMPANY INC.
700 Walnut Street
Elmhurst, IL 60126
630/833-3940
Fax 630/833-9830

INDIANA

HORNER ELECTRIC COMPANY, INC.
1521 East Washington Street
Indianapolis, IN 46201
317/639-4261
Fax 317/639-4342

IOWA

VM HOIST & CRANE SERVICES
PO Box 440
450 Highway 151
Walford, IA 52351
319/846-6040
Fax 319/846-6045

KANSAS

INDEPENDENT ELECTRIC MACHINERY
4425 Oliver Street
Kansas City, KS 66106
913/362-1155 or 800/833-2610
Fax 913/904-3330

LOUISIANA

BEERMAN PRECISION, INC.
PO Box 6018
Metairie, LA 70009
504/207-6000
Fax 504/207-6044

MASSACHUSETTS

ABEL DISTRIBUTORS, INC.
50 Parker Street, Unit 2
Newburyport, MA 01950
978/463-0700
Fax 978/463-5200

NEW JERSEY

SHUPPER-BRICKLE EQUIPMENT CO.
PO Box 803
2394 Route 130, Suite C
Dayton, NJ 08810
732/438-3888
Fax 732/438-3889

NEW YORK

VOLLAND ELECTRIC EQUIPMENT CO.
75 Innsbruck Drive
Buffalo, NY 14227
716/656-9900
Fax 716/656-8899

NORTH CAROLINA

TEAM SESCO
PO Box 667489
2225 Freedom Drive
Charlotte, NC 28208
704/372-4832 or 800/487-3726
Fax 704/358-1098

OHIO

MAZZELLA LIFTING TECHNOLOGIES
21000 Aerospace Parkway
Cleveland, OH 44142-1072
440/239-7000 or 800/362-4601
Fax 440/239-7010

PENNSYLVANIA

AMICK ASSOCIATES, INC.
11 Sycamore Street
PO Box 529
Carnegie, PA 15106-0529
412/429-1212 or 800/445-9456
Fax 412/429-0191

RAM MOTORS & CONTROLS, INC.
5460-B Pottsville Pike, Docks 8-11
PO Box 748
Leesport, PA 19533
610/916-8000
Fax 610/916-7957

SOUTH CAROLINA

ENGINEERED SYSTEMS INC.
1121 Ducan-Reidville Road
Duncan, SC 29334
864/879-7438 or 800/879-7438
Fax 864/879-6428

TEXAS

ABEL EQUIPMENT CO., INC.
3710 Cavalier Drive
Garland, TX 75042
972/272-7706
Fax 972/272-6955

HYDRAULIC EQUIPMENT SERVICES, INC.
1021 North San Jacinto Street
Houston, TX 77002
713/228-9601
Fax 713/228-0931

WISCONSIN

TRESTER HOIST & EQUIPMENT, INC.
W136 N4863 Campbell Drive Suite #4
Menomonee Falls, WI 53051
262/790-0700 or 800/234-6098
Fax 262/790-1009

CANADIAN SERVICE CENTERS

ALBERTA

BENNETT & EMMOTT, LTD.
18131 118TH Avenue
Edmonton, Alberta T5S 1MB
403/454-9000
Fax 403/454-8990

**COLUMBUS MCKINNON, LTD.
10311-174th Street
Edmonton, Alberta T5S 1H1
800/263-1997
Fax 403/486-6160

BRITISH COLUMBIA

FLECK BROTHERS, LTD.
4084 McConnel Court
Burnaby, British Columbia V5A 3N7
604/420-3535
Fax 604/421-8803

MANITOBA

KING'S ELECTRIC MOTORS, INC.
633 Tyne Avenue
Winnipeg, Manitoba R2L 1J5
204/663-5332
Fax 204/663-4059

NOVA SCOTIA

*W & A MOIR
95 Ilsley Ave.
Dartmouth, Nova Scotia B3B 1L5
902/468-7720
Fax 902/468-3777

ONTARIO

*R & W HOIST REPAIR, LTD.
790 Redwood Square
Units 5, 6, & 7
Oakville, Ontario L6L 6N3
905/825-5500
Fax 905/825-5315

*TORONTO ELECTRIC HOIST
SALES & SERVICE
9 Codeco Court
North York, Ontario M3A 1A1
416/386-0820
Fax 416/386-0821

*MASLACK SUPPLY, LTD.
488 Falconbridge Road
Sudbury, Ontario P3A 4S4
705/566-1270
Fax 705/566-6208

*COLUMBUS MCKINNON, LTD.
P.O. Box 1106
10 Brook Road, North
Cobourg, Ontario K9A 4W5
905/372-0153
Fax 905/372-3078

QUEBEC

*HERCULES SLING & CABLE
3800 Transcanada Highway
Pointe-Claire, Quebec H9R 1B1
514/428-5511
Fax 514/428-5555

*LEGER PALANS ET OUTILLAGES, INC.
7995-17th Ave.
Montreal, Quebec H1Z 3R2
514/376-3050
Fax 514/376-0657

* ARE ALSO MASTER PARTS DEPOTS

** MASTER PARTS DEPOT ONLY

SAFETY PRECAUTIONS

Each Valustar Electric Hoist is built in accordance with the specifications contained herein and at the time of manufacture complied with our interpretation of applicable sections of the *American Society of Mechanical Engineers Code B30.16 "Overhead Hoists," the National Electrical Code (ANSI/NFPA 70) and the Occupational Safety and Health Act. Since OSHA states the National Electrical Code applies to all electric hoists, installers are required to provide current overload protection and grounding [on the branch circuit section] in keeping with the code. Check each installation for compliance with the application, operation and maintenance sections of these articles.

The safety laws for elevators, lifting of people and for dumbwaiters specify construction details that are not incorporated into the hoists. For such applications, refer to the requirements of applicable state and local codes, and the American National Safety Code for elevators, dumbwaiters, escalators and moving walks (ASME A17.1). Columbus McKinnon Corporation cannot be responsible for applications other than those for which CM equipment is intended.

*Copies of this standard can be obtained from ASME Order Department, 22 Law Drive, Box 2300, Fairfield, NJ 07007-2300, U.S.A.



THIS SYMBOL POINTS OUT IMPORTANT SAFETY INSTRUCTIONS WHICH IF NOT FOLLOWED COULD ENDANGER THE PERSONAL SAFETY AND/OR PROPERTY OF YOURSELF AND OTHERS. READ AND FOLLOW ALL INSTRUCTIONS IN THIS MANUAL AND ANY PROVIDED WITH THE EQUIPMENT BEFORE ATTEMPTING TO OPERATE YOUR VALUSTAR HOIST.



WARNING

Improper operation of a hoist can create a potentially hazardous situation which, if not avoided, could result in death or serious injury. To avoid such a potentially hazardous situation, the operator shall:

1. **NOT** operate a damaged, malfunctioning or unusually performing hoist.
2. **NOT** operate the hoist until you have thoroughly read and understood this Operating, Maintenance and Parts Manual.
3. **NOT** operate a hoist which has been modified (without the manufacturer's approval or without certification that it is in conformity with ANSI/AMSE B30 volumes).
4. **NOT** lift more than rated load for the hoist.
5. **NOT** use hoist with twisted, kinked, damaged, or worn load chain.
6. **NOT** use the hoist to lift, support, or transport people.
7. **NOT** lift loads over people.
8. **NOT** operate a hoist unless all persons are and remain clear of the supported load.
9. **NOT** operate unless load is centered under hoist.
10. **NOT** attempt to lengthen the load chain or repair damaged load chain.
11. Protect the hoist's load chain from weld splatter or other damaging contaminants.
12. **NOT** operate hoist when it is restricted from forming a straight line from hook to hook in the direction of loading.
13. **NOT** use load chain as a sling, or wrap load chain around load.
14. **NOT** apply the load to the tip of the hook or to the hook latch.
15. **NOT** apply the load unless load chain is properly seated in the chain wheel(s) or sprocket(s).
16. **NOT** apply load if bearing prevents equal loading on all load supporting chains.
17. **NOT** operate beyond the limits of the load chain travel.
18. **NOT** leave load supported by the hoist unattended unless specific precautions have been taken.
19. **NOT** allow the load chain or hook to be used as an electrical or welding ground.
20. **NOT** allow the load chain or hook to be touched by a live welding electrode.
21. **NOT** remove or obscure the warnings on the hoist.
22. **NOT** operate a hoist on which the safety placards or decals are missing or illegible.
23. **NOT** operate a hoist unless it has been securely attached to a suitable support.

24. **NOT** operate a hoist unless load slings or other approved single attachments are properly sized and seated in the hook saddle.
25. Take up slack carefully - make sure load is balanced and load holding action is secure before continuing.
26. Shut down a hoist that malfunctions or performs unusually and report such malfunction.
27. Make sure hoist limit switches function properly.
28. Warn personnel of an approaching load.



CAUTION

Improper operation of a hoist can create a potentially hazardous situation which, if not avoided, could result in minor or moderate injury. To avoid such a potentially hazardous situation, the operator shall:

1. Maintain a firm footing or be otherwise secured when operating the hoist.
2. Check brake function by tensioning the hoist prior to each lift operation.
3. Use hook latches. Latches are to retain slings, chains, etc. under slack conditions only.
4. Make sure the hook latches are closed and not supporting any parts of the load.
5. Make sure the load is free to move and will clear all obstructions.
6. Avoid swinging the load or hook.
7. Make sure hook travel is in the same direction as shown on the controls.
8. Inspect the hoist regularly, replace damaged or worn parts, and keep appropriate records of maintenance.
9. Use the hoist manufacturer's recommended parts when repairing the unit.
10. Lubricate load chain per hoist manufacturer's recommendations.
11. **NOT** use the hoist load limiting or warning device to measure load.
12. **NOT** use limit switches as routine operating stops unless allowed by manufacturer. They are emergency devices only.
13. **NOT** allow your attention to be diverted from operating the hoist.
14. **NOT** allow the hoist to be subjected to sharp contact with other hoists, structures, or objects through misuse.
15. **NOT** adjust or repair the hoist unless qualified to perform such adjustments or repairs.

HOIST SAFETY IS UP TO YOU...

WARNING

– DO NOT LIFT MORE THAN RATED LOAD.

1 CHOOSE THE RIGHT HOIST FOR THE JOB...

Choose a hoist with a capacity for the job. Know the capacities of your hoists and the weight of your loads. Then match them. The application, the size and type of load,

the attachments to be used and the period of use must also be taken into consideration in selecting the right hoist for the job. Remember the hoist was designed to ease

our burden and carelessness not only endangers the operator, but in many cases, a valuable load.



WARNING

– DO NOT OPERATE DAMAGED OR MALFUNCTIONING HOIST.
– DO NOT OPERATE WITH TWISTED, KINKED OR DAMAGED CHAIN.

2 INSPECT



All hoists should be visually inspected before use, in addition to regular, periodic maintenance inspections. Inspect hoists for operational warning notices and legibility. Deficiencies should be noted and brought to the attention of supervisors. Be sure defective hoists are tagged and taken out of

service until repairs are made. Under no circumstances should you operate a malfunctioning hoist. Check chain for gouged, twisted, distorted links and foreign material. Do not operate hoists with twisted, kinked or damaged chain. Load chain should be properly lubricated. Hooks that are bent, worn or whose open-

ings are enlarged beyond normal throat opening should not be used. If latch does not engage throat opening of hook, hoist should be taken out service. Check for misphasing – hook travel should correspond to control direction.



WARNING

– DO NOT PULL AT AN ANGLE. BE SURE HOIST AND LOAD ARE IN A STRAIGHT LINE.

3 USE HOIST PROPERLY



Be sure hoist is solidly held in the uppermost part of the support hook arc.



Be sure hoist and load are in a straight line. Do not pull at an angle.



Be sure load is hooked securely. Do not tip load the hook. Do not load hook latch. Hook latch is to prevent detachment of load under slack chain conditions only.



Do not use load chain as a sling. Such usage damages the chain and lower hook.



Do not operate with hoist head resting against any object. Lift the load gently. Do not jerk it.

WARNING

– DO NOT LIFT PEOPLE OR LOADS OVER PEOPLE.

4 LIFT PROPERLY

Do not lift co-workers with a hoist. Make sure everyone is clear of the load when you lift. Do not remove or obscure operational warning notices.



5 MAINTAIN PROPERLY

CLEANING: Hoists should be kept clean and free of dust, dirt, moisture, etc., which will in any way affect the operation or safety of the equipment.

LUBRICATION: Chain should be properly lubricated.

AFTER REPAIRS: Carefully operate the hoist before returning it to full service.



VIOLATION OF ANY OF THESE WARNINGS LISTED MAY RESULT IN SERIOUS PERSONAL INJURY TO THE OPERATOR OR NEARBY PERSONNEL BY RELEASED LOAD OR BROKEN HOIST COMPONENTS.

FOREWORD

This manual contains important information to help you properly install, operate and maintain your hoist for maximum performance, economy and safety.

Please study its contents thoroughly before putting your hoist into operation. By practicing correct operating procedures and by carrying out the recommended preventive maintenance suggestions, you will experience long, dependable and safe service.

After you have completely familiarized yourself with the contents of this manual, we recommend that you carefully file it for future reference.

The information herein is directed to the proper use, care and maintenance of the hoist and does not comprise a handbook on the broad subject of rigging. Rigging can be defined as the process of lifting and moving heavy loads using hoists and other information, we recommended consulting a standard textbook on the subject.

TABLE OF CONTENTS

SAFETY PRECAUTIONS	PAGE	ASSEMBLY	PAGE
Master Parts Depots	i	Hook or Lug Suspension	16
Do's and Do Not's	ii	Centrifugal Mechanism	16
Hoist Safety is Up To You	iii	Fasteners	16
Foreward	1	Lower Hook Block Pin	16
GENERAL INFORMATION		Removal and Installation of Load Chain	17
Specifications	2	Cutting Chains	18
CM Repair/Replacement Policy	2	Testing	18
ACCESSORIES		REPLACEMENT PARTS	
Series 635 Low Headroom Trolley	3	Ordering Instructions	18
Series 635 Motor Driven Trolley	3	Parts List and Exploded Views	19-25
Rigid Lug Suspension	3		
Chain Container	3		
INSTALLATION			
Unpacking Information	3		
Attaching Suspension	4		
Attaching Load Chain	4		
Installing Accessories	4		
Series 635 Low Headroom Trolley	4		
Series 635 Motor Driven Trolley	6		
Chain Container	6		
Power Supply and Electrical Connections	6		
Three-Phase Hoists	7		
Checking for Adequate Voltage at Hoists	7		
Checking for Twist in Load Chain	8		
OPERATING INSTRUCTIONS			
General	8		
Hoist	8		
Hoist with Low Headroom Trolley	9		
Hoist with Motor Driven Trolley	9		
Safety Procedures	9		
INSPECTION			
Procedures	9		
Frequent Inspections	9,10		
Periodic Inspections	9,10		
Preventive Maintenance	9		
Hook Inspection	11		
Protector	11		
Load Chain	11		
MAINTENANCE			
Hoist Lubrication	12		
Electric Brake Adjustment	12		
Exterior Finish	12		
Trouble Shooting	13		
Recommended Spare Parts	12		
Electrical Data	14		
Wiring Diagrams	17		

LIST OF TABLES	
1 Specifications	2
2 Trolley Side Frame Spacing	7
3 Min. Frequent Inspections	10
4 Min. Periodic Inspections	10
5 Electrical Data	14

LIST OF ILLUSTRATIONS	
1 Series 635 Low Headroom Trolley	3
2 Series 635 Motor Driven Trolley	3
3 Rigid Lug Suspension	3
4 Chain Container	3
5 Suspension Assemblies	4
6 Load Chain Attachment	5
7 Series 635 Low Headroom Trolley	6
8 Attaching Hoist to Trolley	6
9 Hook Inspection	11
10 Gaging Load Chain Wear	11
11 Typical Wiring Diagrams	15
12 Hook Suspension	16
13 Centrifugal Mechanism Assembly	16
14 Cutting Chain by Nicking	18
15 Cutting Chain with Bolt Cutter	18
16 Exploded View, Control Station	22
17 Exploded View, Hoist	23-24
18 Exploded View, Series 635 Low Headroom Trolley	25

GENERAL INFORMATION

SPECIFICATIONS

The Valustar Electric Chain Hoist is a highly versatile materials handling device that can be used to lift loads that are within rated capacity. The mechanical features of these hoists include an alloy steel lift wheel, overload device (Protector), hardened steel chain guides, simple two stage gear reduction, lifetime lubrication, forged steel hooks and lightweight aluminum frames. The electrical features include hoist-duty motor, magnetic reversing contactor, rugged control station, heavy-duty motor brake and control transformer (3 phase units). Hoists are supplied with a rigid upper hook suspension as standard. Table 1 summarizes the hoist's specifications.

CM REPAIR/REPLACEMENT POLICY

All Columbus McKinnon (CM) Valustar Electric Chain Hoists are inspected and performance tested prior to shipment. If

any properly maintained hoist develops a performance problem, due to a material or workmanship defect, as verified by CM, repair or replacement of the unit will be made to the original purchaser without charge. This repair/replacement policy applies only to Valustar Hoists installed, maintained and operated as outlined in this manual, and specifically excludes parts subject to normal wear, abuse, improper installation, improper or inadequate maintenance, hostile environmental effects and unauthorized repairs/modifications.

We reserve the right to change materials or design if, in our opinion, such changes will improve our product. Abuse, repair by an unauthorized person, or use of non-CM replacement parts voids the guarantee and could lead to dangerous operation. For full Terms of Sale, see Sales Order Acknowledgement. Also, refer to the back cover for Limitations of Warranties, Remedies and Damages, and Indemnification and Safe Operation.

Table 1

Valustar Electric Chain Hoist Specifications

CODE	DC CODE	MODEL	MAX. CAP. (TONS)	LIFTING SPEED F.P.M.	MOTOR H.P.	MIN. HOOK DISTANCE	POWER SUPPLY VOLTS/PHASE/HERTZ	NET WEIGHT (POUNDS)
2401	62401	WB	1/4	16	1/4	16-1/2"	115-1-60	51
2402	62402	WB	1/4	16	1/4	16-1/2"	230/460-3-60	61
2413	62413	WE	1/2	8	1/4	19-7/8"	230/460-3-60	72
2412	62412	WE	1/2	8	1/4	19-7/8"	115-1-60	62
2403	62403	WF	1/2	16	1/2	16-1/2"	115-1-60	53
2404	62404	WF	1/2	16	1/2	16-1/2"	230/460-3-60	68
2405	62405	WH	1	8	1/2	19-7/8"	115-1-60	69
2406	62406	WH	1	8	1/2	19-7/8"	230/460-3-60	78
2414	62414	WJ	1/2	32	1	17-5/8"	230/460-3-60	105
2407	62407	WL	1	16	1	17-5/8"	115-1-60	109
2408	62408	WL	1	16	1	17-5/8"	230/460-3-60	106
2409	62409	WR	2	8	1	24-1/2"	115-1-60	129
2410	62410	WR	2	8	1	24-1/2"	230/460-3-60	126

Series 635 Low Headroom Trolley Specifications

MAX. CAP. (TONS)	FOR USE WITH MODELS	ADJUSTABLE FOR S-BEAMS	TREAD DIA. OF WHEELS (IN.)	MIN. RADIUS CURVE (IN.)
1/4 to 1	WB, WE, WF, WH, WJ, WL	4" X 7.7# TO 15" X 50#	3-1/8	24
2	WR	6" X 12.5# TO 18" X 54.7#	4-3/4	24

Series 635 Motor-Driven Trolley Specifications

MAX. CAP. (TONS)	FOR USE WITH MODELS	POWER SUPPLY	TRAVEL SPEED (FPM)	MOTOR H.P.	ADJUSTABLE FOR S-BEAMS	MIN. RADIUS CURVE (IN.)
1/4 to 2	WB, WE, WF, WH, WJ, WL, WR	115-1-60 230-3-60 or 460-3-60	75	1/4	6" x 12.5" thru 15" x 50#	30

ACCESSORIES

Series 635 Low Headroom Trolley

These are manual push type trolleys designed for use with the Valustar Electric Chain Hoists, and a rigid lug suspension is required to attach the hoist to the trolley (see Figure 1). The trolley is adjustable to operate on a range of American Standard beams as indicated in Table 1, and it will also operate on flat flanged beams.

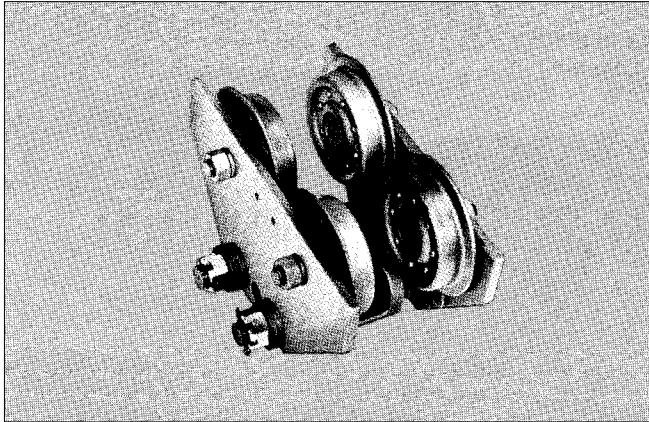

Figure 1. Series 635 Low Headroom Trolley

Series 635 Motor Driven Trolley

The motor driven trolley is self-contained and supplied complete with controls and wiring, ready for attachment to any of the Valustar Electric Hoists (see Figure 2). A rigid lug suspension is required to attach the hoist to the trolley, and complete instructions are provided to electrically and mechanically attach the hoist to the trolley. The trolley is adjustable to operate on a range of American Standard beams as indicated in Table 1, and it will operate on flat flanged beams.



Figure 2. Series 635 Motor Driven Trolley

Rigid Lug Suspension

This suspension is required for attaching the hoist to the Low Headroom or Motor Driven Trolley (see Figure 3). It must be ordered separately with the hoist model and trolley type specified.

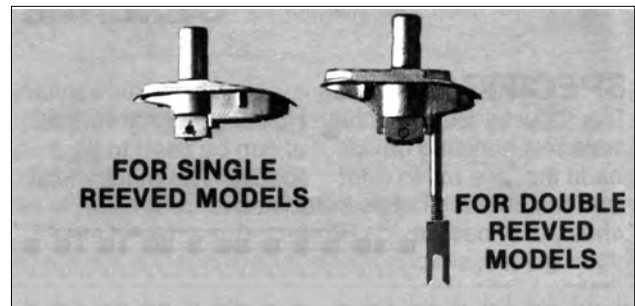

Figure 3. Rigid Lug Suspension

Chain Container

This accessory is used to hold the slack chain, and it is supplied complete with mounting hardware and mounting instructions. The chain container is recommended for those applications where the slack chain would interfere with the load. Chain containers can be furnished for units already in use. When ordering, specify hoist model and lift.



Figure 4. Chain Container

INSTALLATION

UNPACKING INFORMATION

When received, the hoist should be carefully inspected for damage which may have occurred during shipment or handling. Check the hoist frame for dents or cracks, the external cords for damaged or cut insulation, the control station for cut or damaged enclosure, and inspect the load chain for nicks and gouges. If shipping damage has occurred, refer to the packing list envelope on the carton for claim procedure.

Before installing the hoist, make sure that the power supply to which it will be connected is the same as that shown on the nameplate located on the side of the hoist.

Note: To assure extra long life and top performance, be sure to follow the load chain lubricating instructions on Page 12.

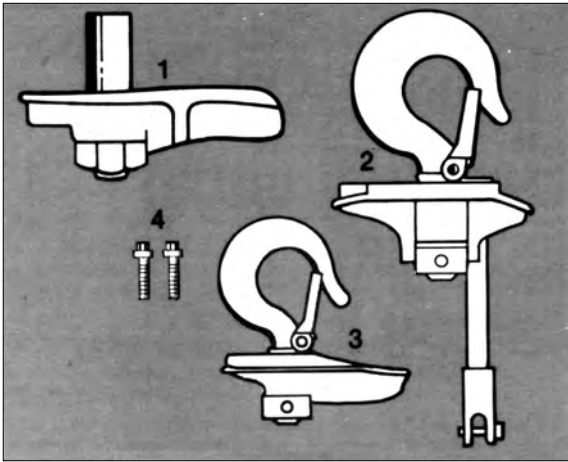

Figure 5. Suspension Assemblies

1. Lug type (single reeved adapter) for use with Low Headroom Trolley and Motor Driven Trolley.
2. Swivel hook type (double-reeved adapter).
3. Rigid Hook Type (single-reeved adapter).
4. 12 point suspension screws.
(Do not order parts by these numbers. See parts list.)

ATTACHING SUSPENSION

1. Remove the hook suspension from the carton and the two, 12 point suspension screws from the bag, see Figure 5. The suspension for a double chain hoist (Models WE, WH and WR) includes a dead end bolt and block for supporting the dead end of the load chain as shown in Figure 5.
2. Place the suspension in the recess on top of hoist. On double chain hoist, the dead end block should project through the bottom of hoist with the pin hole and slot aligned to the underside of hoist as shown in Figure 6. It may be necessary to lift the bolt head from the hex recess in the suspension adapter, turn and reseal it, to obtain this alignment. **DO NOT CHANGE THE POSITION OF THE DEAD END BLOCK ON THE BOLT.** The pin hole should clear the hoist frame by not more than 1/4" on Models WE and WH and 7/16" on Model WR.
3. Insert the screws through the adapter and engage the self-locking nuts enclosed in the hoist. Screws will enter the nuts freely except for the last 1/4" of travel during which the resistance of the nut locking collar will be encountered.
4. Securely tighten the screws to the recommended seating torque specified in the table below, using a 12 point socket which fits the head of the screw.

Model No.	Screw Size	Recommended Seating Torque
WB, WE, WF and WH	3/8-16 UNC-3A	30-45 Lb. Ft.
WJ, WL, and WR	1/2-20 UNF-3A	40-80 Lb. Ft.

! WARNING

Using other than CM supplied high strength suspension screws to attach the suspension adapter to the hoist may cause the screws to break and allow the hoist and load to fall.

TO AVOID INJURY:

Use only the CM supplied suspension screws to attach the suspension to the hoist and torque these screws to the recommended seating torque as specified above.

Also, do not apply any type of lubricant to the threads of these screws. Lubricating the threads will reduce the effort to seat the screws and, as a result, tightening the screws to the above recommended torque may break the screw, damage the suspension adapter, strip the nuts and/or damage the hoist frame.

ATTACHING LOAD CHAIN

Models WE, WH and WR

1. Suspend the hoist from an adequate support.
2. The hoist is shipped with the dead end of the load chain temporarily positioned a few links from the end by a plastic tie (1) as shown in Figure 6. Do not remove this plastic tie until the chain is secured.
3. On Models WE and WH, insert the last link of the load chain into the dead end block (2) and secure it with the dead end pin, washer and cotter pin furnished with the suspension. Remove the plastic tie (1) by cutting with a pair of electrical pliers.

On Model WR, remove the plastic tie (1) by cutting with a pair of electrical pliers. Slide the contact block up the chain until it is against the bottom of the hoist and the dead end block is projecting through the square opening in the bottom of the block. Insert the last link of the load chain, making sure there are no twists between the hook block and the dead end block, into the dead end block. Push the contact block up slightly and secure the load chain to the dead end block using the dead end pin, washer and cotter pin furnished with the suspension. The dead end pin also supports the contact block.

4. Do not remove the ties from the load chain until after the hoist is suspended from its permanent support or tract system. Now, suspend the hoist from its permanent support or tract system. If the hoist is to be hung from a Low Headroom Trolley or a Motor Driven Trolley, refer to the trolley installation instructions.

INSTALLING ACCESSORIES

Series 635 Low Headroom Trolley

(See Figure 7)

! WARNING

Operating the trolley on a beam that has no rail stops may allow the trolley to fall off the end of beam.

TO AVOID INJURY:

Install rail stops at each end of the beam on which the trolley is to operate.

To attach the hoist to the trolley a lug suspension (Figure 3) is required. The trolley and lug suspension are packed separately, and the hook suspension that is packed with the hoist may be discarded. To install the lug suspension, follow the instructions for attaching the suspension on this page.

To adjust the trolley to fit the beam properly, proceed as follows:

1. Arrange the side frames, load bracket, spacer washers and nuts on the suspension bolts according to Figure 7 and Table 2. Do not assemble cotter pins to the bolts.

Note: special trolleys shown in chart require special suspension bolts.

2. The number of spacers as given in Table 2 is nominally correct, however, due to the variation in size encountered on structural steel sections, it will be necessary in some cases to vary the number used. Therefore, the distance

TEMPORARY CHAIN SUPPORT

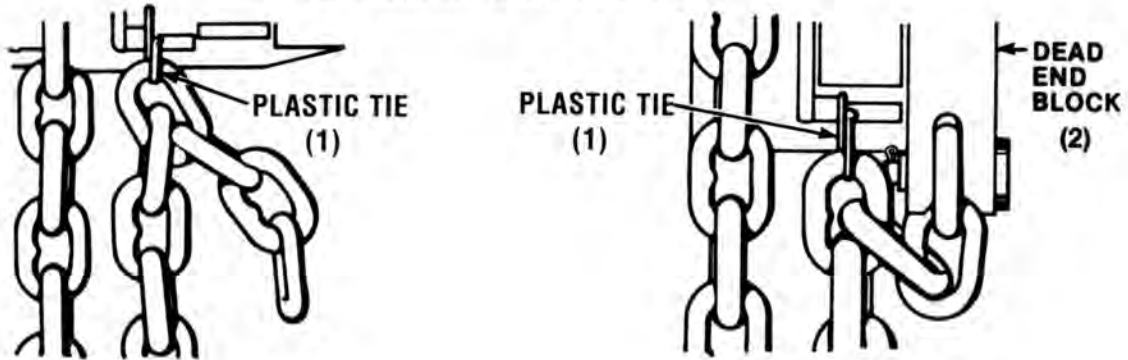

LOOSE END ATTACHMENT

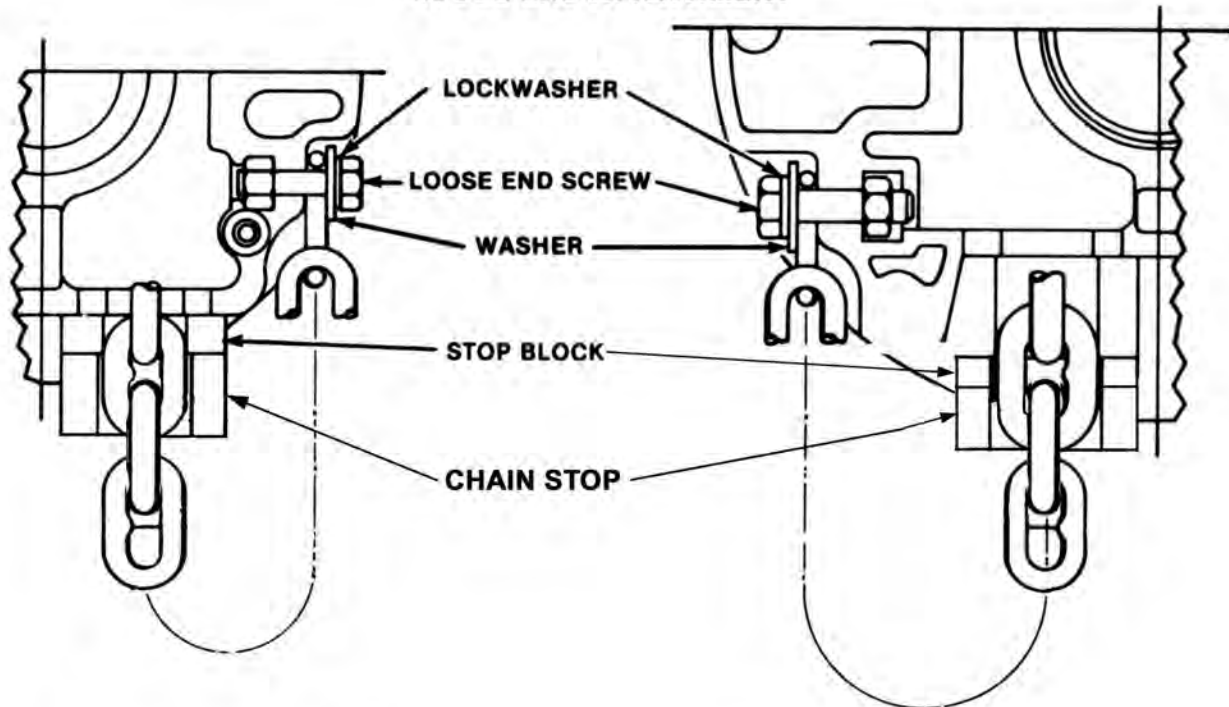

MODELS WE, WB, WF AND WH

MODELS WJ, WL, AND WR

CONTACT BLOCK

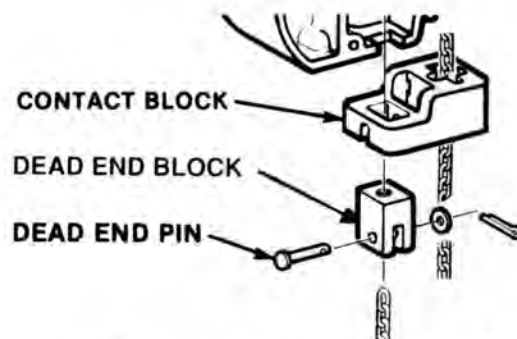

NOTE: Model WR is furnished with a contact block. The dead end block passes through the contact block and the contact block is supported by the dead end pin.

Figure 6. Load Chain Attachment

Figure 6. Load Chain Attachment

between the trolley trackwheel flanges and the beam flange width should be measured to determine the exact distribution of the spacer washers. The number of spacer washers between side frames and load bracket should be the same or differ only by one spacer to keep the hoist hook centered under the beam.

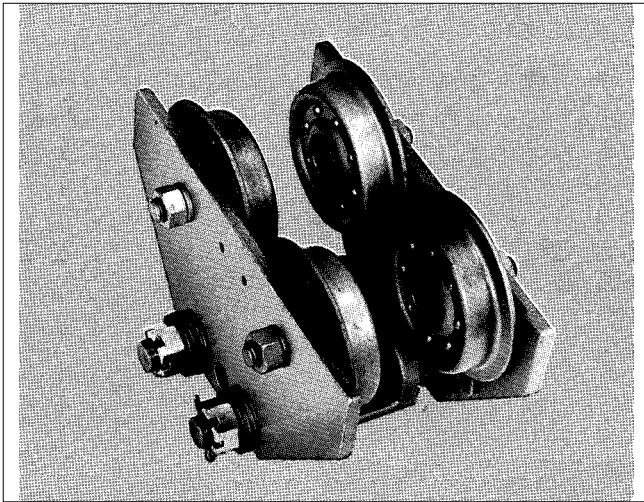

Figure 7. Series 635 Low Headroom Trolley

Note: Due to the variations in beam flange widths, it is suggested that the beam flange width be measured to determine the exact distribution of spacer washers. The distance between trackwheel flanges (dimension "X") should be 1/8 to 3/16 inch greater than the beam flange width for straight runway beams, and 3/16 to 1/4 inch greater than the beam flange width if runway system includes sharp curves. Also, the use of other than CM supplied washers may result in trackwheel to beam flange variations and thus Table 2 will not apply.

3. Install the trolley on beam by sliding one side of frame out far enough to allow the trackwheels to clear the beam flange.

WARNING

If CM's washer spacing recommendations are not followed, trolley may fall from beam.

TO AVOID INJURY:

Measure the actual beam flange on which the trolley is to operate and use Table 2 to determine the arrangement of the spacer washers for that flange width.

4. Draw the side frames together and assemble cotter pins.
5. With the trolley mounted on the beam, attach the hoist by inserting the suspension lug into the trolley load bracket and inserting the suspension pin through the load bracket and suspension lug as shown in Figure 8. Secure the pin using the socket head cap screw and lockwasher.
6. Thread the socket head cap screw and lockwasher into load bracket and tighten securely.
7. Now, refer to "Power Supply and Electrical Connections" on this page and complete the hoist installation procedure.
8. Then with a capacity load on hoist, operate trolley over the entire length of runway or monorail system to be sure that the adjustment and operation is satisfactory. On systems with curves, keep the rail edges at the curved sections lightly greased.

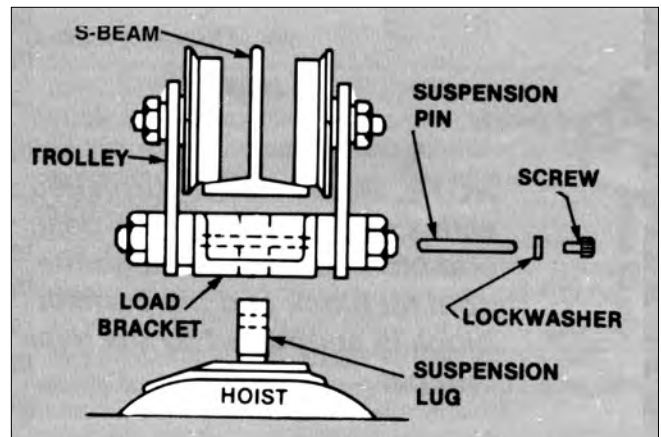

Figure 8. Attaching Hoist to Trolley

WARNING

An excessively worn beam flange may fail and allow the trolley to fall from the beam.

TO AVOID INJURY:

Periodically inspect the beam flange for wear. Replace beam if flange is worn.

Series 635 Motor Driven Trolley

To attach the hoist to the trolley, a lug suspension (Figure 3) is required. The trolley and lug suspension are packed separately, and the hook suspension that is packed with the hoist may be discarded. To install the lug suspension, follow the instructions for attaching the suspension on page 4. The Motor Driven Trolley must be assembled and wired to the hoist by the user per the manual packed with the trolley.

Chain Container

For installation instruction, refer to instruction sheet packed with the chain container.

POWER SUPPLY AND ELECTRICAL CONNECTIONS

All Hoists

The hoist should be connected to a branch circuit which complies with the requirements of the National Electrical Code and applicable local codes.

It is recommended, especially for a single phase hoist with a one horsepower motor, that a line of adequate capacity be run directly from the power supply to the hoist to prevent having problems with low voltage and circuit overloads.

For grounding of the hoist, the power cord includes a grounding conductor (green wire). On a standard single phase unit this cord is equipped with a three-prong plug. Be sure that the receptacle opening which receives the longest prong is properly grounded. Furthermore, the suspension system on which the hoist is mounted should also be permanently grounded.

Before connecting the hoist to the power supply, check that the power to be used agrees with that shown on the hoist identification label. In addition, for a three phase, dual voltage unit, check the voltage shown on the tag attached to power cord.

Table 2**Trolley Side Frame Spacing**

	FLANGE WIDTH	1-TON CAPACITY NO. OF SPACERS				2-TON CAPACITY NO. OF SPACERS			
		A	B	C	D	A	B	C	D
STANDARD TROLLEYS	2-5/8	10	0	0	10				
	3	9	1	1	9				
	3-3/8	8	2	2	8	8	0	0	8
	3-5/8	7	3	3	7	7	1	1	7
	4	6	4	4	6	6	2	2	6
	4-5/8	4	6	6	4	4	4	4	4
	5	3	7	7	3	3	5	5	3
	5-1/4	2	8	8	2	3	5	6	2
	5-1/2	1	9	8	2	2	6	7	1
	5-5/8	1	9	9	1	1	7	7	1
SPECIAL TROLLEYS	6					0	8	8	0
	6	5	5	5	4				
	6-1/4	4	6	6	3	8	2	1	8
	7	0	9	9	1	5	5	4	5
	7-1/8					5	5	5	4
	7-1/4					4	6	5	4
	7-7/8					2	8	8	1
	8					1	9	8	1

Minimum Beam Radius 24" for all capacities. Dimension applies to minimum S-Beam and will vary with larger S-Beams.

The nominal hoist voltage rating corresponding to the voltage range given on hoist identification label is:

SINGLE SPEED UNITS	
Range	Nominal Volts
110-120	115
220-240	230
440-480	460

Three Phase Hoists

Changing the voltage connections on a single speed, three phase dual voltage unit is easily accomplished by following the instructions on the wiring diagram provided with the hoist.

Since the motor in a three phase hoist can rotate in either direction, depending on the manner in which it is connected to the power supply, the direction of hook movement must be checked during the original installation and each time hoist is moved to a new location.

1. Make temporary connections at the power supply.
2. Operate ▲ (UP) control in control station momentarily. If hook raises, connections are correct and can be made permanent.
3. If hook lowers, it is necessary to change direction by interchanging the Red Lead and the Black Lead of the hoist power cord at power supply. Under no circumstances should the internal wiring of control station or hoist be changed to reverse hook direction. The wiring is inspected and tested at the factory.



WARNING

Allowing the hook block to run into the bottom of the hoist when raising a load or allowing the loose end block to run into the bottom of the hoist when lowering a load may break the chain and allow the load to drop.

TO AVOID INJURY:

Do not allow the hook block or the loose end block to contact the bottom of the hoist.

Checking for Adequate Voltage at Hoist

The hoist must be supplied with adequate electrical power in order to operate properly. For proper operation, the voltage, (measured at the end of the hoist power cord) must be as indicated in the table below:

NOMINAL POWER SUPPLY	MINIMUM RUNNING VOLTAGE	MINIMUM STARTING VOLTAGE
115-1-60	104	98
230-3-60	198	—
460-3-60	396	—

Signs of Inadequate Electrical Power (Low Voltage) are:

- Noisy hoist operations due to brake and/or contactor chattering.
- Dimming of lights or slowing of motors connected to the same circuit.
- Heating of the hoist motor and other internal components, as well as heating of the wires and connectors in the circuit feeding the hoists.
- Failure of the hoist to lift the load due to motor stalling.
- Blowing of fuses or tripping of circuit breakers.

To avoid these low voltage problems, the hoist must be connected to an electrical power supply system that complies with the National Electrical Code and applicable local codes. This system must also be rated for a minimum of 20 amps and it must have #14 AWG or larger wiring, a disconnecting means, overcurrent protection (slow blow fuses or inverse-time type circuit breakers) and provisions for grounding the hoist.



WARNING

Failure to properly ground the hoist presents the danger of electric shock.

TO AVOID INJURY:

Permanently ground the hoist as instructed in this manual.

Low voltage can also be caused by using an undersize extension cord to supply power to the hoist. The following chart should be used to determine the size wires in the extension cord in order to minimize the voltage drop between the power source and the hoist.

LENGTH OF EXTENSION CORD	SINGLE-PHASE HOISTS MIN. WIRE SIZE	THREE-PHASE HOISTS MIN. WIRE SIZE
Up to 50 feet	#14 AWG	#16 AWG
80 feet	#12 AWG	#16 AWG
120 feet	#10 AWG	#14 AWG



WARNING

Failure to provide a proper power supply system for the hoist may cause hoist damage and offers the potential for a fire.

TO AVOID INJURY:

Provide the hoist with a 20 amp. minimum, overcurrent protected power supply system per the National Electrical Code and applicable local codes as instructed in this manual.

Remember, operation with low voltage can void the CM repair/replacement policy. When in doubt about any of the electrical requirements, consult a qualified electrician.

Note: Always disconnect the power from the power supply system and lockout/tagout disconnecting means before servicing the hoist.



WARNING

Working in or near exposed energized electrical equipment presents the danger of electrical shock.

TO AVOID INJURY

Disconnect power and lockout/tagout disconnecting means before removing cover or servicing this equipment.

Checking for Twist in Load Chain Models WE, WH and WR

The best way to check for this condition is to run the lower hook, without a load, up to within about 2" of hoist. If the dead-end of the chain has been properly installed, a twist can occur only if the lower hook block has been capsized between the strands of chain. Reverse capsize to remove twist.

OPERATING INSTRUCTIONS

GENERAL

The hoist is equipped with a Protector™ that is designed to allow the intermediate gear to slip on an excessive overload. An overload is indicated when the hoist will not raise the load. Also, some clutching noise may be heard if the hoist is loaded beyond rated capacity. Should this occur, immediately release the up ▲ control to stop the operation of the hoist. At this point, the load should be reduced to the rated hoist capacity or the hoist should be replaced with one of the proper capacity. When the excessive load is removed, normal hoist operation is automatically restored.

CAUTION: The Protector™ is susceptible to overheating and wear when slipped for extended periods. Under no circumstance should the clutch be allowed to slip for more than a few seconds.

Due to the above, the hoist is not recommended for use in any application where there is a possibility of adding to an already suspended load to the point of overload. This includes dumbwaiter installation (refer to limitations discussed in Safety Precautions on Page ii), containers that are loaded in mid-air, etc. Also, if the hoist is used at unusual extremes of ambient temperatures, above 150°F. or below 15°F., changes in lubricant properties may permit the hoist to raise larger loads than under normal operating conditions and present possibility of damage or injury.

On single phase units, it is necessary to stop the hoist before changing direction. Therefore, when lowering a load, the rocker in the control station must be released momentarily before the up ▲ control is depressed to raise the load. If this is not done, the hoist will continue to operate in the down direction while the up ▲ control is depressed, and it will continue to lower the load until the control rocker is released. As a result, on the single phase units, the direction must not be reversed quickly (plug reversed).

There are no electrical switches to stop the operation of the hoist at the upper and lower limits of the lift. As a result, it is necessary to release the rocker in the control station to stop the hoist before the hook block or loose end block contacts the bottom of the hoist frame. If the hook block or loose end block contacts the hoist frame, the Protector™ will function to stop the hoisting or lowering operation and protect the hoist components from damage. However, continued, prolonged or repeated slipping of the Protector™ will damage the Protector™ and cause overheating of the internal hoist components.

HOIST

1. Before picking up a load, check to see that the hoist is directly overhead.
2. **WHEN APPLYING A LOAD, IT SHOULD BE DIRECTLY UNDER HOIST OR TROLLEY. AVOID OFF CENTER LOADING OF ANY KIND.**
3. Take up a slack load chain carefully and start load easily to avoid shock and jerking of hoist load chain. If there is any evidence of overloading, immediately lower the load and remove the excess load.
4. **DO NOT** allow the load to swing or twist while hoisting.
5. **DO NOT** allow the load to bear against the hook latch.

HOIST WITH LOW HEADROOM TROLLEY

This unit should be moved by pushing on the suspended load or by pulling the empty hook. However, the unit can also be moved by pulling on the control station since an internal steel cable extends the length of the control cord and is anchored to the hoist and to the control station.

HOIST WITH MOTOR DRIVEN TROLLEY

This unit should be moved by operating the controls marked **▶** (Forward) and **◀** (Reverse) in control station. Unless altered by the erector, depressing **▶** (Forward) control will move the hoist toward motor housing end. Anticipate the stopping point and allow trolley to coast to a smooth stop. Reversing or “plugging” to stop trolley causes overheating of motor and swaying of load.

SAFETY PROCEDURES

For safety precautions and a list of **DO'S** and **DO NOT'S** for safe operation of hoists, refer to **page ii**.

- When preparing to lift a load, be sure that the attachments to the hook are firmly seated in hook saddle. Avoid off center loading of any kind, especially loading on the point of hook.
- When lifting, raise the load only enough to clear the floor or support and check to be sure that the attachments to the hook and load are firmly seated. Continue to lift only after you are assured the load is free of all obstructions.
- DO NOT** load hoist beyond the rated capacity shown on hoist identification plate or on the hoist motor housing cover or hoist back frame cover. Overload can cause immediate failure of some load-carrying part or create a defect causing subsequent failure at less than rated capacity. When in doubt, use the next larger capacity of CM Valustar Hoist.
- DO NOT** use this or any other overhead materials handling equipment for lifting persons.
- Stand clear of all loads and avoid moving a load over the heads of other personnel. Warn personnel of your intention to move a load in their area.
- DO NOT** leave the load suspended in the air unattended.
- Permit only qualified personnel to operate unit.
- DO NOT** wrap the load chain around the load and hook onto itself as a choker chain.
Doing this will result in:
 - The loss of the swivel effect of the hook which could mean a twisted chain and a jammed lift wheel.
 - The chain could be damaged at the hook.
- On two part-reeved hoists, check for twists in the load chain. A twist can occur if the lower hook block has been capsized between the strands of chain. Reverse the capsize to remove twist.
- DO NOT** allow the load to bear against the hook latch.
The latch is to help maintain the hook in position while the chain is slack before taking up slack chain.



WARNING

Allowing the load to bear against the hook latch and/or hook tip can result in loss of load.

TO AVOID INJURY:

Do not allow the load to bear against the hook latch and/or hook tip. Apply load to hook bowl or saddle only.

- Take up a slack load chain carefully and start load easily to avoid shock and jerking of hoist load chain. If there is any evidence of overloading, immediately lower the load and remove the excess load.
- Do not allow the load to swing or twist while hoisting.

INSPECTION

PROCEDURES

To maintain continuous and satisfactory operation, a regular inspection procedure must be initiated to replace worn or damaged parts before they become unsafe. Inspection intervals must be determined by the individual application and are based on the type of service to which the hoist will be subjected and the degree of exposure to wear, deterioration or malfunction of the critical components.

The type of service which the hoist is subjected can be classified as “**NORMAL**,” “**HEAVY**,” “**SEVERE**.”

NORMAL SERVICE: Involves operation with randomly distributed loads within the rated load limit, or uniform loads less than 65 percent of rated load for not more than 25 percent of the time.

HEAVY SERVICE: Involves operating the hoist within the rated load limit which exceeds normal service.

SEVERE SERVICE: Is normal or heavy service with abnormal operating conditions.

Two classes of inspection, **FREQUENT** and **PERIODIC**, must be performed.

FREQUENT INSPECTIONS: These inspections are visual examinations by the operator or other designated personnel. Records of such inspections are not required. The frequent inspections are to be performed monthly for normal service, weekly to monthly for heavy service, and daily to weekly for severe service, and they should include those items listed in Table 3.

PERIODIC INSPECTIONS: These inspections are visual inspections of external conditions by an appointed person. Records of periodic inspections are to be kept for continuing evaluation of the condition of the hoist. Periodic inspections are to be performed yearly for normal service, semi-annually for heavy service and quarterly for severe service, and they are to include those items listed in Table 4.

CAUTION: Any deficiencies are to be corrected before the hoist is returned to service. Also, the external conditions may show the need for disassembly to permit a more detailed inspection, which, in turn, may require the use of non-destructive type testing.

Preventive Maintenance

In addition to the above inspection procedure, a preventive maintenance program should be established to prolong the useful life of the hoist and maintain its reliability and continued safe use. The program should include periodic and frequent inspections with particular attention being paid to the lubrication of the various components using the recommended lubricants (see page 12).

Table 3**Minimum Frequent Inspections**







Type of Service			Item
Normal	Heavy	Severe	
 Yearly	 Weekly to Yearly	 Daily to Weekly	<ul style="list-style-type: none"> a) Brake for evidence of slippage. b) Control functions for proper operation. c) Hooks for damage, cracks, twists, excessive throat opening, latch engagement and latch operation – see page 11. d) Load chain for adequate lubrication, as well as for signs of wear, damaged links or foreign matter – see page 11. e) Load chain for proper reeving and twists.

Table 4**Minimum Periodic Inspections**

Type of Service			Item
Normal	Heavy	Severe	
 Yearly	 Every Six Months	 Every Three Months	<ul style="list-style-type: none"> a) All items listed in Table 3 for frequent inspections. b) External evidence of loose screws, bolts or nuts. c) External external evidence of worn, corroded, cracked or distorted hook block, suspension bolts, gears, bearings, loose end chain, stop block, loose end block and pins, and dead end block and pin (double reeved units). d) External evidence of damage to hook retaining nut or collar and pin. Also check the upper suspension adapter making sure it is fully seated in the hoist frame and retighten the screws to the recommended seating torque (see page 4). If a condition of loose screws persists, replace the self-locking nuts in the frame. e) External evidence of damage or excessive wear of the liftwheel and hook block sheave (double reeved units) chain pockets. Widening and deepening of the pockets may cause the chain to lift-up in the pocket and result in binding between liftwheel and chain guides or between the sheave and hook block (double reeved units). Also, check the chain guides for wear or burring where the chain enters the hoist. Severely worn or damaged parts should be replaced. f) External evidence of excessive wear or brake parts and brake adjustment – see page 12. g) External evidence of pitting or any deterioration of contactor contacts. h) Inspect the electrical cords and cables for damaged insulation. i) Inspect trolley trackwheels for external wear on tread and flange, and for wear on internal bearings surfaces as evidenced by a looseness on the stud.

LATCH TYPE HOOK (Upper and Lower)

TO MEASURE OPENING,
DEPRESS LATCH
AGAINST HOOK BODY
AS SHOWN

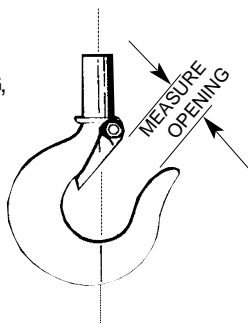

Models	Replace Hook When Opening is Greater Than
WB, WF	1-3/16
WE, WH, WJ & WL	1-5/16
WR	1-1/2

Figure 9. Hook Inspection

Hook Inspection

Hooks damaged from chemicals, deformations or cracks, or that have more than a 10° twist from the hook's unbent plane or excessive opening or seat wear must be replaced. Also, hooks that are opened and allow the latch to not engage the tip, must be replaced. Any hook that is twisted or has excessive throat opening indicates abuse or overloading of the unit. Inspect other load sustaining parts for damage.

On latch type hooks, check to make sure that the latch is not damaged or bent and that it operates properly with sufficient spring pressure to keep the latch tightly against the tip of the hook and allow the latch to spring back to the tip when released. If the latch does not operate properly, it should be replaced. See Figure 9 to determine when the hook must be replaced.

Protector™

The Protector™ should operate for the normal life of the hoist without service. The device has been lubricated and calibrated at the factory for a specific model of hoist and is not adjustable or interchangeable with other models. For proper overload protection be sure before installing a Protector™ that it is correct for the unit. The spring washer of the Protector™ has been color coded at the factory as follows:

Models	Protector™ Color Code
WB, WE	White
WE, WH	Orange
WJ	Red
WL, WR	Green



WARNING

Removing the snap ring on the Protector™ assembly will allow the parts to spring apart.

TO AVOID INJURY:

Do not attempt to disassemble the Protector™.

LOAD CHAIN

Clean and Inspection

First clean the load chain with a non-acid or non-caustic type solvent, then slack the chain and make a link-by-link inspec-

tion for nicks, gouges, twisted links, stretching and excessive wear. In particular, observe the bearing surface between links, and if any of these conditions exist, the load chain must be replaced. Chain should be gaged throughout its entire length and replaced if beyond serviceable limits.

To determine if load chain should be continued in service, check gage lengths as indicated in Figure 10. Chain worn beyond length indicated, nicked, gouged or twisted should be replaced before returning hoist to service. Chain should be clean, free of twists and pulled taut before measuring. In cases where the wear is localized and not beyond serviceable limits, it is sometimes possible to reverse the load chain, end for end, and allow a new section to take the wear. Removal and installation of the load chain is covered in subsequent paragraphs.

To aid in gaging load chain wear. A chain gage can be obtained from CM. This can be obtained by ordering chain gage Part No. 3191.

CAUTION: Before installing new load chain, the unit must be disassembled to allow inspection for damage or wear and replacement, if required, of mating parts (liftwheel, chain guides, motor and gear housings).

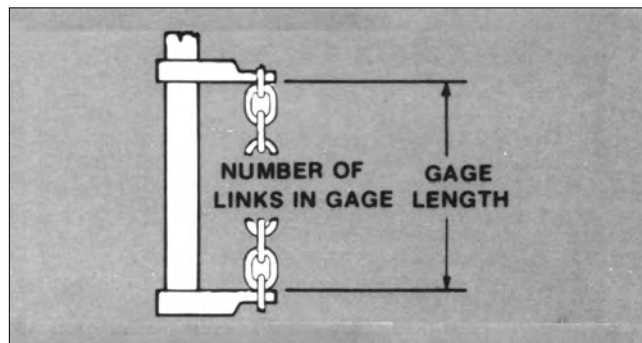

Figure 10. Gaging Load Chain Wear

Models	Dia. of Chain Stock	No. of Links to Gage	Max. Gage Length Allowable Used Chain
WE, WB, WF & WH	0.250"	19	14-13/16"
WJ, WL, and WR	0.312"	21	18-7/8"

When installing new load chain or mating parts, refer to Lubrication on page 12.

IMPORTANT: Do not use replaced chain for other purposes such as lifting or pulling. Load chain may break suddenly without visual deformation. For this reason, cut worn chain into short lengths to prevent use after disposal.



WARNING

Using other than CM supplied load chain may cause the chain to jam in the hoist and/or allow the chain to break and the load to drop.

TO AVOID INJURY:

Due to size requirements and physical properties, use only CM HOISTALOY® load chain in the CM Valustar Hoists.

MAINTENANCE



WARNING

The lubricants used in and recommended for the Valustar Hoist may contain hazardous materials that mandate specific handling and disposal procedures.

TO AVOID CONTACT AND CONTAMINATION:

Handle and dispose of lubricants only as directed in applicable material safety data sheets and in accordance with applicable local, state and federal regulations.

HOIST LUBRICATION

NOTE: To assure extra long life and top performance, be sure to lubricate the various parts of the Valustar Hoist using the lubricants specified below. If desired, these lubricants may be purchased from CM. Refer to page 22 for information on ordering the lubricants.

Gears

The Protector™ should operate for the normal life of the hoist without service. The device has been lubricated and calibrated at the factory for a specific model of hoist and is not adjustable or interchangeable.

CAUTION: The Protector™ is to be used with “Century Lubricants HB-11, #3” grease. Use of any other grease will damage Protector™ parts or cause improper operation.

The gears and Protector™ are factory greased and should not need to be renewed unless the gears have been removed from the housing and degreased.

CAUTION: Never degrease or attempt to disassemble the Protector™. Degreasing may damage parts or cause erratic, inconsistent operation. If the Protector™ has been degreased, it must be replaced by a factory calibrated device.

If the gears are removed from the housing, wipe the excess grease off the outside Protector™ surfaces with a soft cloth and degrease the remaining gears and housings. Upon reassembly, add 7 oz. of above grease to gears and housing. Also, coat the spline on the end of the drive shaft with a molydisulphide lubricant such as “Super Herculon.”

Bearings

All bearings and bushings except the lower hook thrust bearing are prelubricated and require no lubrication. Lubricate the lower hook thrust bearing at least once a month, using a heavy cup grease.

Chain Guides, Liftwheel & Lower Sheave Wheel

When the hoist is disassembled for inspection and/or repair, the chain guides, lower sheave wheel (on double chain units) and liftwheel must be lubricated with Lubriplate, Bar and Chain Oil 10-R (Fiske Bros. Refining Co.) prior to reassembly. Apply sufficient lubricant to obtain run-off and full coverage.

Load Chain

A small amount of lubricant will greatly increase the life of load chain. Do not allow the chain to run dry. Keep it clean and lubricate at regular intervals with Lubriplate, Bar and Chain Oil 10-R (Fiske Bros. Refining Co.) or equal lubricant. Normally, weekly lubrication and cleaning is satisfactory, but under hot and dirty

conditions, it may be necessary to clean the chain at least once a day and lubricate it several times between cleanings.

When lubricating the chain, apply sufficient lubricant to obtain natural run-off and full coverage.



WARNING

Used motor oils contain known carcinogenic materials.

TO AVOID HEALTH PROBLEMS:

Never use used motor oils as a chain lubricant. Only use Lubriplate Bar and Chain Oil 10-R as a lubricant for the load chain.

Low Headroom Trolley

CM trackwheel bearings are pre-lubricated and require no lubrication.

ELECTRIC BRAKE ADJUSTMENT

The correct air gap between armature and field, when brake is not energized, is 0.035 inch and need not be adjusted until the gap reaches 0.075 inches. To adjust the brake, proceed as follows:

1. Disconnect hoist from power supply.
2. Remove back frame cover.
3. Before adjusting the gap:
 - a) back off the stud nuts and examine friction linings and friction surfaces for excessive wear, scoring or warpage.
 - b) check shading coils to be sure they are in place and not broken. A missing or broken shading coil will cause noisy brake operation.

These symptoms indicate the need for parts replacement.

4. Turn adjusting nuts clockwise gaging the air gap at both ends.
5. Replace cover, reconnect the power and check operation.

EXTERIOR FINISH

The exterior surfaces of the hoist and trolleys have a durable, scratch resistant baked powder coating. Normally, the exterior surfaces can be cleaned by wiping with a cloth. However, if the finish is damaged, compatible touch-up paint can be purchased from CM. Refer to page 22 for information on ordering the paint.

RECOMMENDED SPARE PARTS

To insure continued service of the Valustar Hoist, the following is a list of parts that are recommended to be kept on hand at all times to replace parts that have worn or failed:

Key No.	Part Name	Qty. for each Hoist in Service
624-197	Brake Friction Disc Models WB & WE	1
	All Other Models	2
624-199	Brake Coil	1
624-213	Capacitor (115-1-60 Units Only)	1
624-215	Cut-Out Switch (115-1-60 Units Only)	1
624-216	Contactora	1
624-218	Transformer (Three-phase Units Only)	1
624-306	Control Station Parts Kit	1
624-307	Control Station Switch Kit	1
624-778	Solid State Reverse Switch	1

Refer to Page 21 for ordering information and parts list for the part numbers.

TROUBLE SHOOTING

— Probable Cause —

— Remedy —

— Probable Cause —	— Remedy —
1. Hook does not respond to control station.	
<ul style="list-style-type: none"> A. No voltage at hoist – main line or branch circuit switch open; branch line fuse blown or circuit breaker tripped. B. Phase failure (single-phasing, three-phase unit only) – open circuit, grounded or faulty connection in one line of supply system, hoist wiring, reversing contactor, motor leads or windings. C. Open control circuit – open or shorted winding in transformer or reversing contactor coil; loose connection or broken wire in circuit; mechanical binding in contactor; control station contacts not closing or opening D. Wrong voltage or frequency. E. Low voltage. F. Brake not releasing – open or shorted coil winding; armature binding. G. Excessive load. 	<ul style="list-style-type: none"> A. Close switch, replace fuse or reset breaker. B. Correct power supply system. Check for electrical continuity and repair or replace defective part. C. Check electrical continuity and repair or replace defective part. D. Use the voltage and frequency indicated on hoist identification label. E. Correct low voltage condition as described on page 7. F. Check electrical continuity and connections. Check that correct coil has been installed. The coil for three phase dual voltage unit operates at 230 volts when the hoist is connected for either 230 volt or 460 volt operation. Check brake adjustment (page 12). G. Reduce load to the capacity limit of hoist as indicated on the hoist identification label.
2. Hook moves in wrong direction.	
<ul style="list-style-type: none"> A. Wiring connections reversed at the control station. B. Failure of the motor cut-out switch to effect dynamic braking at time of reversal (single-phase units only). C. Phase reversal (three-phase units only). 	<ul style="list-style-type: none"> A. Use wiring diagram and check wiring connections. B. Check connections to switch. Replace damaged switch or faulty capacitor. C. Refer to installation instructions page 7.
3. Hook lowers but will not raise.	
<ul style="list-style-type: none"> A. Excessive load. B. Open hoisting circuit – open or shorted winding in reversing contactor coil; loose connection or broken wire in circuit; control station contacts are not making. C. Motor cut-out device not operating. (single-phase units only). D. Phase failure (three-phase units only). 	<ul style="list-style-type: none"> A. See item 1G. B. Check electrical continuity and repair or replace defective part. C. Check the switch connections and actuating bar and contact for sticking or damage. Check centrifugal mechanism for loose or damaged components. Replace defective parts. D. See item 1B.
4. Hook raises but will not lower.	
<ul style="list-style-type: none"> A. Open lowering circuit – open or shorted winding in reversing contactor coil; loose connections or broken wire in circuit; control station contacts not making. B. Motor cut-out switch not operating (single-phase units only). 	<ul style="list-style-type: none"> A. Check electrical continuity and repair or replace defective part. B. See item 3C.
5. Hook lowers when hoisting control is operated.	
<ul style="list-style-type: none"> A. Phase failure (three-phase units only). 	<ul style="list-style-type: none"> A. See item 1B.
6. Hook does not stop promptly.	
<ul style="list-style-type: none"> A. Brake slipping. B. Excessive load. 	<ul style="list-style-type: none"> A. Check brake adjustment as described on page 12. B. See item 1G.
7. Hoist operates sluggishly.	
<ul style="list-style-type: none"> A. Excessive load. B. Low voltage. C. Phase failure or unbalanced current in phases (three-phase units only). D. Brake dragging. 	<ul style="list-style-type: none"> A. See item 1G. B. Correct low voltage condition as described on page 7. C. See item 1B. D. Check brake adjustment as described on page 12.
8. Motor overheats.	
<ul style="list-style-type: none"> A. Excessive load. B. Low voltage. C. Extreme external heat. D. Frequent starting or reversing. E. Phase failure or unbalanced current in the phases (three-phase units only). F. Brake dragging. G. Motor cut-out device not opening start winding circuit (single-phase units only). 	<ul style="list-style-type: none"> A. See item 1G. B. Correct low voltage condition as described on page 7. C. Above an ambient temperature of 104°F (40°C), the frequency of hoist operation must be limited to avoid overheating the motor. Special provisions should be made to ventilate the space or shield the hoist from radiant heat. D. Avoid excessive inching, jogging or reversing. This type of operation drastically shortens the motor and contactor life and causes excessive brake wear. E. See item 1B. F. Check brake adjustment as described on page 12. G. See Item 3C.
9. Hook fails to stop either or both.	
<ul style="list-style-type: none"> A. Shaft not rotating. 	<ul style="list-style-type: none"> A. Check for damaged gears.

ELECTRICAL DATA

To Detect Open and Short Circuits in Electrical Components

Open circuits in the coils of electrical components may be detected by isolating the coil and checking for continuity with an ohmmeter or with the unit in series with a light or bell circuit.

Shorted turns are indicated by a current draw substantially above normal (connect ammeter in series with suspected

element and impose normal voltage) or D.C. resistance substantially below normal. The current method is recommended for coils with very low D.C. resistance.

Motor current draw in the stator should be measured with the rotor in place and running. Brake, relay and contactor coil current should be measured with the core iron in operating position.

Table 5

Electrical Data for Hoist Components

TRANSFORMER

Voltage	Leads	D.C. Resistance (Ohms)*
230/480 TO 115	Secondary: Blue-tan to Blue	19.5
	Primary: Red-black to Red-blue	87.5
	Primary: White-red to White-green	99.0

CONTACTOR

Models Voltage	Coil (Volts)	Normal Current (Amps)	D.C. Resistance (Ohms)*
WB, WE, WF & WH	120	.04	297.5
WJ, WL, and WR	120	.04	297.5

BRAKE COIL

Rated Voltage	Nominal Current (Amps) at Rated Voltage	D.C. Resistance (Ohms)*
115	0.5	6.2
230**	0.25	24.7

MOTORS

Models	Voltage Phase & Hertz	H.P.	Full Load Current (Amps)	Leads	*D.C. Resistance (Ohms)
WB, WE	115-1-60	1/4	4.6	5 TO 8 (START) T1 to T2 T3 to T4	4.9 4.3 4.3
WB, WE	230/460 3-60	1/4	1.4/.70	1 to 4 2 to 5 3 to 6 7 to 8 7 to 9 8 to 9	14.8 14.8 14.8 29.5 29.5 29.5
WF, WH	115-1-60	1/2	7.2	5 to 8 (START) T1 to T2 T3 to T4	3.7 3.8 3.8
WF, WH	230/460 3-60	1/2	1.8/.90	1 to 4 2 to 5 3 to 6 7 to 8 7 to 9 8 to 9	7.8 7.8 7.8 15.6 15.6 15.6
WL, WR	115-1-60	1	9.8	5 to 8 (START) T1 to T2 T3 to T4	1.3 1.1 1.1
WJ, WL, WR	230/460 3-60	1	3/1.5	1 to 4 2 to 5 3 to 6 7 to 8 7 to 9 8 to 9	4.7 4.7 4.7 9.4 9.4 9.4

*Resistance values listed are nominal and they may vary slightly from component to component.

**On dual-voltage units connected for 460 volts, brake coils operate on 230 volts.

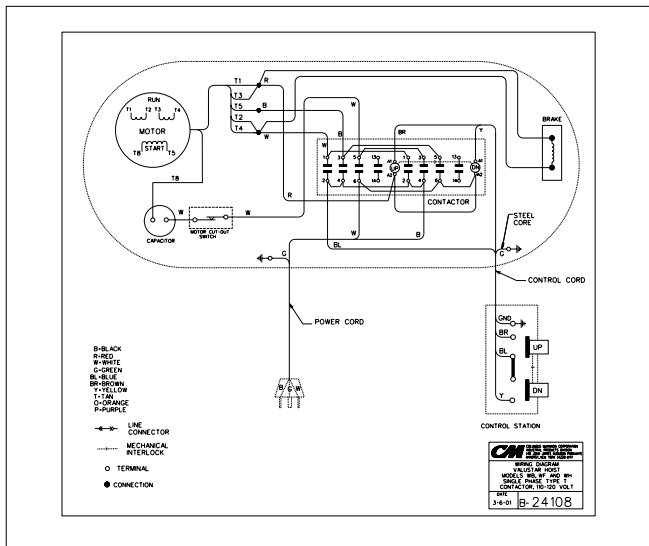

SINGLE PHASE-TYPE 'T' CONTACTOR
110-120 VOLT

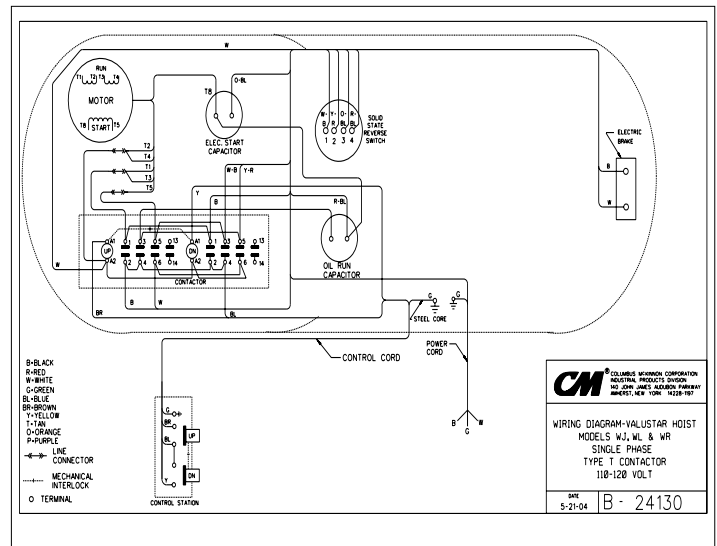

SINGLE PHASE-TYPE 'T' CONTACTOR
110-120 VOLT

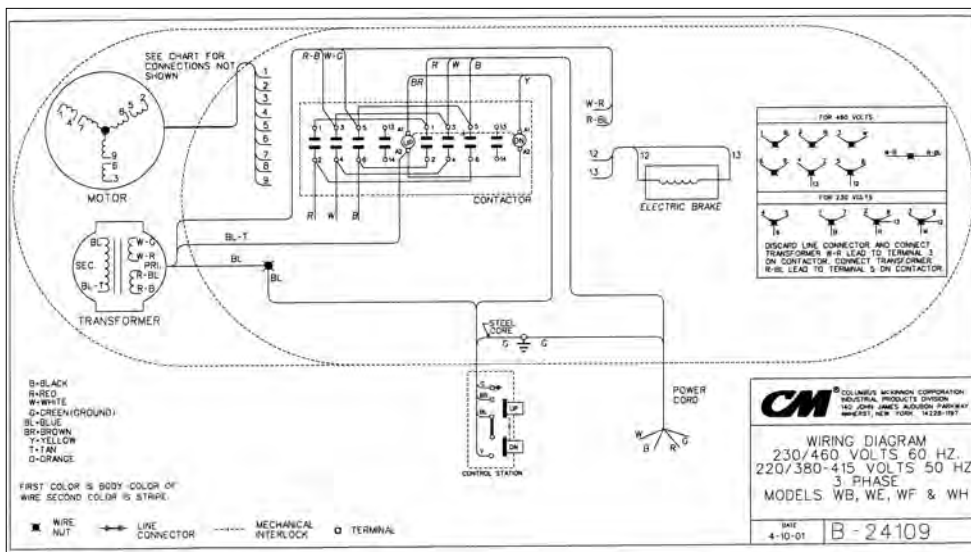

THREE PHASE
230/460-3-60
220/380-415-3-50
MODELS WB, WE, WF &
WH

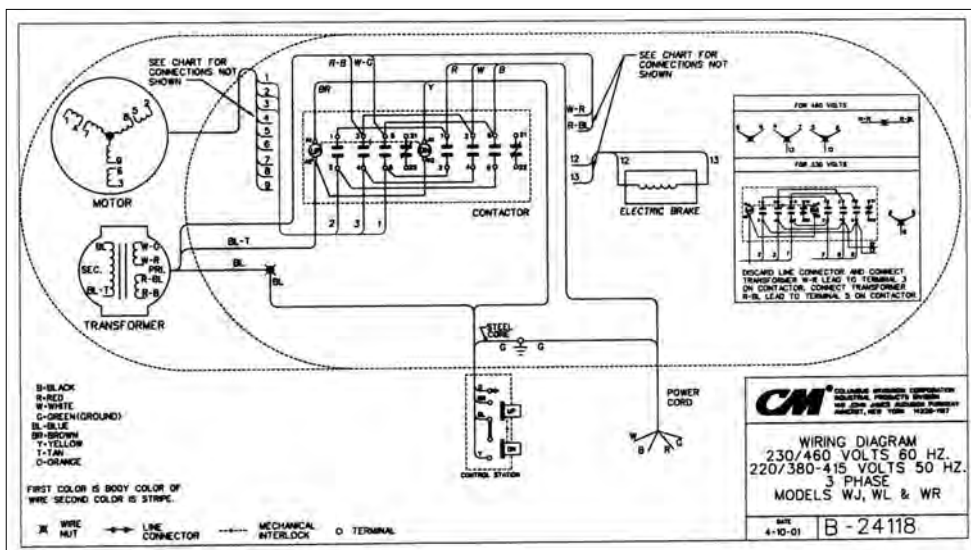

THREE PHASE
230/460-3-60
220/380-415-3-50
MODELS WJ, WL & WR

Figure 11. Typical Wiring Diagrams. Wiring Diagrams shown are representative. Consult diagram in Hoist or furnished with unit.

ASSEMBLY

HOOK OR LUG SUSPENSION

Models WE, WH, and WR

Assemble the dead end bolt and block through the suspension adapter, as shown in Figure 12.

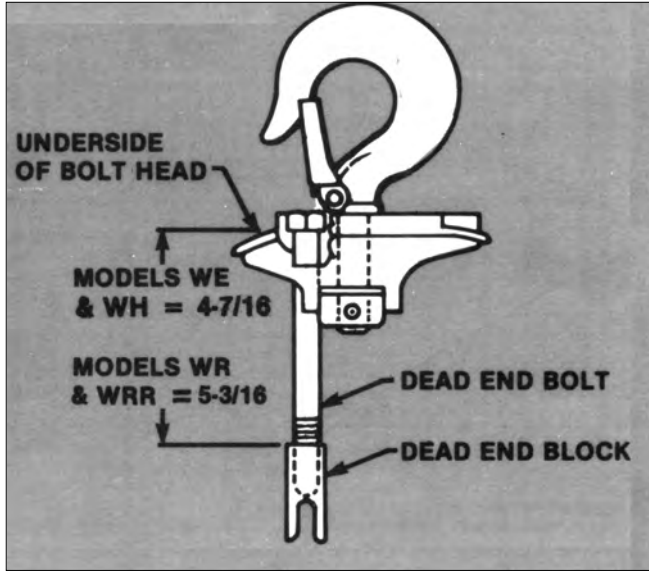

Figure 12. Hook Suspension

CENTRIFUGAL MECHANISM

Centrifugal mechanism (624-212) is furnished in kit form which contains the centrifugal mechanism, spacers and an Instruction Sheet. The Instruction Sheet provides complete details on the installation of replacement mechanism.

To install the replacement mechanism, a press-on tool as shown in Figure 13 will be required. The press-on tool is not included in the kit, however, it may be ordered from CM – order centrifugal mechanism press-on tool part number 28598.

When installing the replacement centrifugal mechanism, the spacer is placed between the rotor shaft shoulder and the centrifugal mechanism as shown in Figure 13. Using a slow-acting press, apply pressure to the press-on tool and press the mechanism onto the shaft until it sets against the spacer. To prevent damaging the mechanism and/or spacer, the force applied to the press-on tool press the mechanism onto the shaft should not exceed 3000 pounds.

FASTENERS

Models WE, WB, WF and WH, tighten motor housing cover screws (624-106) to where they have a minimum breakaway torque of 48 pound inch.

Models WJ, WL and WR tighten motor thru bolts (624-140) to where they have a minimum breakaway torque of 50 pound inch.

The liftwheel gear nut (624-139) should be tightened to a seating torque of 85 pound feet.

LOWER HOOK BLOCK PIN

When removing or installing the lower hook chain block pin (624-764), care must be taken so as to prevent damaging the pin and/or hook block. These pins are tapered groove pins and, as a result, they can only be removed in one direction. To remove the pin, a V-Block, drift and hammer (or slow acting press) are required. The drift should be the same diameter as the pin (5/16" diameter for Models WB, WE, and WF and 3/8" diameter for Models WJ and WL) and it should be placed on

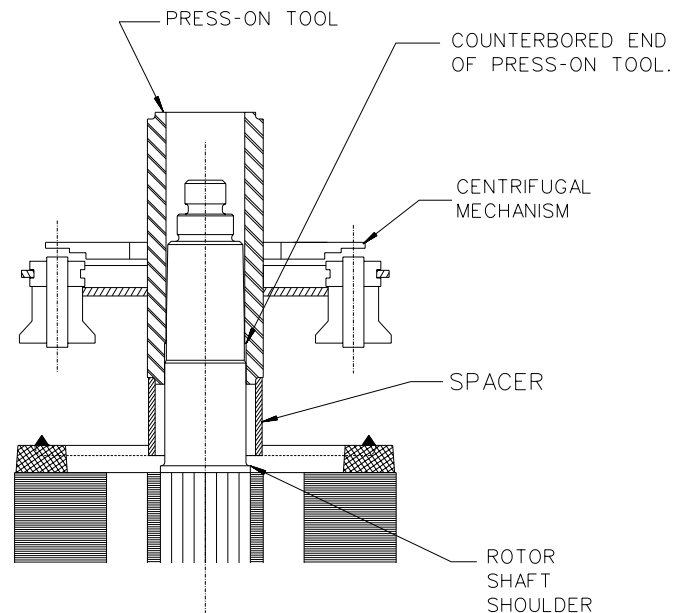
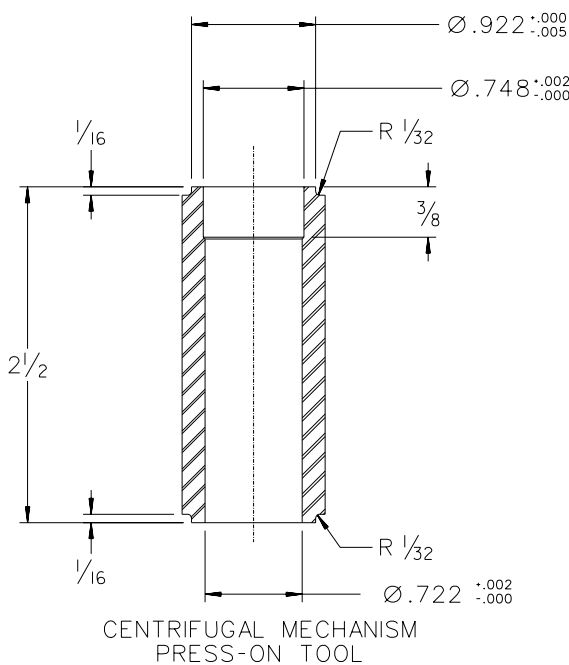

Models WB, WE, WF and WH

Figure 13. Centrifugal Mechanism Assembly

the small end of the pin. The small end of the pin is the end opposite the end on which the three grooves are visible. Place the hook block in the V-Block and drive the pin out using the drift and a hammer or slow acting press.



WARNING

Use of improper lower hook chain block pin as well as improper installation of this pin can cause the pin to break and allow the load to fall.

TO AVOID INJURY AND PROPERTY DAMAGE:
Use only CM supplied, special high strength lower hook chain block pin to attach the chain to the lower hook block and install the pin as directed above.

To re-install the pin, the parts must be arranged the same as they were when the pin was removed. To do this, use the small end of the pin as a gage. First check the holes in the hook block body and determine which hole is the largest. Place the hook block body in the V-Block with the larger hole on top. Next, check each end of the hole in the lower hook chain block (624-775) and determine which end is the largest. Place the chain in the slot of the chain and insert the chain block, with the large hole on top, into the hook block body. Align the holes in the hook block body with the hole in the chain block and insert the small end of the pin in the hole. Push the pin in by hand until it stops and then use a hammer or slow acting press to drive the pin into position so that the end of the pin is flush with the outside surface of the hook block body.

REMOVAL AND INSTALLATION OF LOAD CHAIN



WARNING

Improper installation (reeving) of the load chain can result in a dropped load.

TO AVOID INJURY/DAMAGE:
Verify use of proper size and type of hoist load chain for specific hoist.

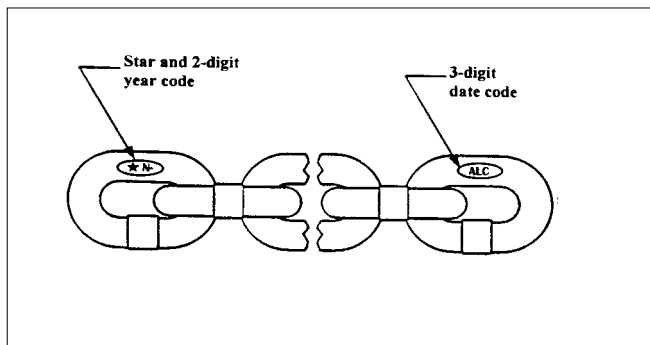

Use only CM Star (®) Grade Load Chain and CM replacement parts. Use of other chain and parts may be dangerous and voids factory warranty.



WARNING

Use of commercial or other manufacturers' chain and parts to repair CM Hoists may cause load loss.

TO AVOID INJURY:
Use only CM supplied replacement load chain and parts. Chain and parts may look alike, but CM chain and parts are made of specific material or processed to achieve specific properties.

1. Disconnect hoist from power supply.
2. Detach loose end chain from hoist frame. Remove loose end block and stop block from the old load chain.
3. Using the following procedures (cutting chains) cut a portion out of the second to last link (flat link) on the loose side of the old chain to form a coupling link. The portion removed should be centered on the weld and be 3/8" long. Remove any burrs from the cut edges of the coupling link. Discard the last link.
4. Connect the new chain to the old chain using the coupling link. The coupling link should be a flat link and the first link of the new chain should be an upstanding link. Be sure the welds on the upstanding links are away from the liftwheel.
5. Re-energize power supply and operate hoist in the down direction until approximately two and one-half (2-1/2') feet of the new chain is hanging free on the loose end side. Make sure that the last link of the new chain is an upstanding link. Slide the stop block onto the new chain and attach the loose end block to the chain using the load chain pin. Next, attach the loose-end chain to the hoist frame using the loose-end screw washer and plain washer.

Note: If hoist is equipped with a chain container, do not attach the loose end chain to the hoist frame.

6. On single reeved units, remove the lower hook block from the old chain and remove the coupling link. Reassemble the hook block to the last link of the new chain. (See above-lower hook block pin.)

On double reeved units, pull the new chain through the hook block using the old chain and coupling link. Be sure there are no twists in the chain and the first link of the new chain is a flat link.

NOTE: Upstanding links in the hook block will have weld towards the sheave.

Remove the coupling link and remove the old chain from the dead end block at the hoist. Run the new chain up to the dead end block making sure there is no twist in the chain between the hook block and dead end block.

Attach the last link (flat link) of the new chain to the dead end block.

If the hoist is completely disassembled when the new chain is to be installed, the new chain should be placed over the liftwheel (with weld on upstanding links away from liftwheel). Leave 2-1/2' of chain hanging free on the loose end side. Refer to steps 5 and 6 above to complete the installation.

Note: On the double chain units, it will be necessary to use a length of soft wire to pull the new chain through the hook block in lieu of using the coupling link and old chain as indicated.

If the starter chain method is not used, the chain can be installed by partially disassembling the hoist. Remove the loose-end chain, loose-end block and stop block from the chain. Then, energize the hoist to carefully run the old chain out of the hoist. Disconnect the hoist from the power supply and remove the electric brake assembly. Rotate the brake hub by hand, at the same time feeding the new chain into and through liftwheel area with the hoist upside down or using a soft wire to pull the chain up onto the liftwheel. Be sure that the weld on the upstanding link is away from the liftwheel. Refer to steps 5 and 6 above to complete the installation.

NOTE: On the double reeved units, it will be necessary to use a length of soft wire to pull the new chain through the hook block in lieu of using the coupling link and old chain as indicated.

CUTTING CHAINS

CM Hoistaloy® load chain is hardened and it is difficult to cut. The following methods are recommended when cutting a length of new chain from stock or cutting off worn chain.

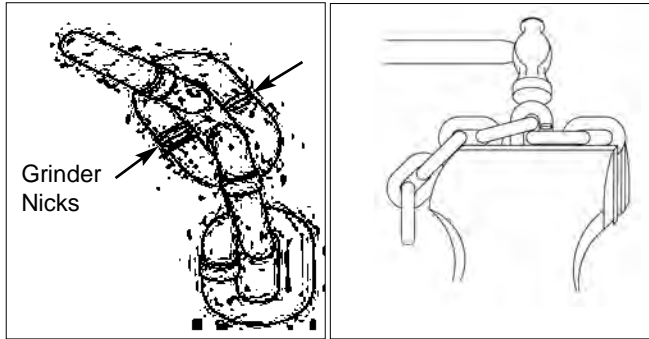

Figure 14. Cutting Chain by nicking

1. Use a grinder and nick the link on both sides (Figure 14), then secure the link in a vise and break off with a hammer.
2. Use a 7" minimum diameter by 1/8" thick abrasive wheel (or type recommended by wheel supplier) that will clear adjacent links.

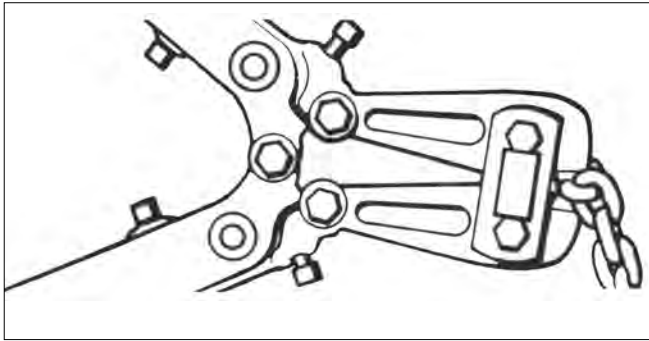

Figure 15. Cutting Chain with a bolt cutter

3. Use a bolt cutter (Figure 15) similar to the H.K. Porter No. 0590MTC with special cutter jaws for cutting hardened chain (1" long cutting edge).

WARNING

Cutting chain can produce flying particles.

TO AVOID INJURY:

Wear eye protection. Provide a shield over chain to prevent flying particles.

TESTING

Before using, all altered, repaired or used hoists that have not been operated for the previous 12 months shall be tested by the user for proper operation.

1. Test the unit without a load.
2. Test the unit with a light load of 50 pounds times the number of load supporting parts of load chain. Check to see that the hoist operates properly and that the brake holds the load when the control is released.
3. Test with a load of 125%* of rated capacity. Hoists in which load sustaining parts have been replaced should be tested with 125%* of rated capacity by or under the direction of an appointed person and a written report prepared for record purposes.
4. After test 3, check that the Protector functions. If the

Protector™ permits lifting a load in excess of 200% of rated load, it should be replaced.

*If the protector prevents lifting a load of 125% of rated capacity, reduce load to rated capacity.

NOTE: For additional information on inspection and testing, refer to Code B30.16 "Overhead Hoists" obtainable from ASME Order Department, 22 Law Drive, Box 2300, Fairfield, NJ 07007-2300, U.S.A.

REPLACEMENT PARTS

ORDERING INSTRUCTIONS

The following information must accompany all correspondence or orders for replacement parts:

1. Hoist Model Number from identification label.
2. Serial number of the hoist stamped below identification plate.
3. Voltage, Phase, Hertz from identification label.
4. Length of lift.
5. Key number of part from parts list.
6. Number of parts required.
7. Part name from parts list.
8. Part number from the parts lists.

If trolley replacement parts are ordered, also include the type and capacity of the trolley.

NOTE: When ordering replacement parts, it is recommended that consideration be given to the need for also ordering such items as gaskets, fasteners, insulators, etc. These items may be damaged or lost during disassembly or just unfit for future use because of deterioration from age or service.

WARNING

Using "commercial" or other manufacturer's parts to repair the CM Valustar Hoist may cause load loss.

TO AVOID INJURY:

Use only CM supplied replacement parts. Parts may look alike, but CM parts are made of specific materials or processed to achieve specific properties.

PARTS LIST

KEY NO.	PART NAME	NUMBER REQUIRED		PART NUMBERS							
		Models WB, WE, WF, WH	Models WJ, WL, WR	Model WB	Model WE	Model WF	Model WH	Model WJ	Model WL	Model WR	
624-100	Motor Housing	1	1	27028				24008			
624-101	Gear Housing	1	1	28669 (Includes Item 624-102)				35620 (Includes Items 624-102, 624-120, 624-129)			
624-102	Intermediate Gear and Pinion Bearing - Inboard (Includes Shaft Adapter for WJ, WL, WR)	1	1	88440				Order 83670 (Bearing) and 24350 (Shaft Adapter)			
624-103	Chain Guide	2	2	27008				35018			
624-104	Liftwheel	1	1	27360				35421			
624-105	Suspension Adapter Nut	2	2	927755				935791			
624-106	Motor Housing Cover Screw and Lockwasher	2	2	C302				C303			
624-107	Liftwheel Gear Retainer Ring	1	---	27767				---			
624-108	Motor Shaft Bearing, Inboard Retainer Ring	2	2	27790				35764			
624-109	Gear Housing Attaching Screw and Lockwasher	4	4	Order 28830 Screw and 940802 Lockwasher				Order 982682 Screw and 940830 Lockwasher			
624-110	Loose End Screw, Washer and Lockwasher	1	1	C304				C305			
624-111	Motor Shaft Bearing - Outboard	1	---	82009				---			
624-112	Motor Shaft Bearing - Inboard	1	1	82003				82004			
624-113	Stator Pin	1	---	983541				---			
624-114	Control Cable Screw, Washer and Lockwasher	1	1	C306				C306			
624-115	Back Frame Assembly (Includes Brake Studs)	1	1	24620 (Includes 624-116 thru 624-118, 624-127, 624-128)				24622			
624-116	Drive Shaft and Pinion Bearing	1	1	82009				83691			
624-117	Intermediate Gear and Pinion Bearing - Outboard	1	1	82009				88437			
624-118	Bearing Retainer Screw and Washers	1	2	C307				C308			
624-119	Back Frame Attaching Screw and Lockwasher	3	4	Order 982699 Screw and 940802 Lockwasher				Order 982682 Screw and 940830 Lockwasher			
624-120	Liftwheel Bearing - Gear End	1	1	88429				82002			
624-121	Motor Housing Cover	1	1	24504				24759			
624-122	Back Frame Cover	1	1	24757				24758			
624-123	Back Frame Cover Attaching Screw and Lockwasher	2	2	C309				C310			
624-125	Hoist I.D. Label 115-1-60, 230/460	1	1	Contact Factory				Contact Factory			
624-126	Capacity/Warning Label	1	1	24764	24765	24765	24766	24765	24766	24768	
624-127	Hole Plug Set	4	1	982454				C311			
624-128	Back Frame Expansion Plug	1	---	940837				---			
624-129	Gear Housing Plug	---	1	---				935767			
624-130	Drive Shaft and Pinion Assembly (Includes Items 624-131 thru 624-133 for Models WB, WE, WF, WH, WJ, WL and WR. Also Includes Item 624-116 with Models WJ, WL, WR)	1	1	Order 624-116, 624-131, 624-132 and 624-133				24639	24638	24638	
624-131	Drive Shaft and Pinion Assembly	1	1	24641 (8T. Pinion, 5-15/64" Long)		24642 (8T Pinion, 5 43/64" Long)		35357 (18T.)	35356 (12T.)	35356 (12T.)	
624-132	Brake Hub	1	1	27851 (8T. 21/32" Long)		27852 (8T. 1-1/8" Long)		---	24019 (13T.)	24019 (13T.)	
624-133	Brake Hub Retainer Ring	1	1	27766				35766			
624-134	Liftwheel Gear	1	1	27009 (53T.)				35009 (79T.)			
624-135	Intermediate Pinion	1	1	24351 (8T.)				35351 (10T.)			
624-136	Intermediate Gear Retainer Ring	1	1	27765				35763			
624-137	Protector	1	1	28694		28695		36668	36670	36670	
624-138	Liftwheel Bearing - Motor End	1	1	88429				83669			
624-139	Liftwheel Gear Nut and Lockwasher	---	1	---				C312			

PARTS LIST, continued

Key No.	Part Name	NUMBER REQUIRED		PART NUMBERS						
		Models WB, WE, WF, WH	Models WJ, WL, WR	Model WB	Model WE	Model WF	Model WH	Model WJ	Model WL	Model WR
624-140	Motor Attaching Screw and Lockwasher	---	4	---			For all Units, order (4) 87377 Motor Thru Bolts and (4) 982226 Lockwashers			
624-142	Loose End Nut	1	1	82638			82639			
624-143	Contact/Capacitor Bracket with Attaching Screws	---	1	Order (1) Bracket 24200 and (1) Screw 982688			Order Bracket 35701 and (2) Screws 983643			
624-145	Capacitor Clamp with Attaching Screws and LockWasher	---	1	---			Order (1) 35268 Clamp, (1) 982210 Washer, (1) 983544 Lockwasher and (1) 987354 Screw			
624-146	Loose End Link	1	1	35367			35367			
624-147	Contact Block	---	1	---			---	---	36764	
624-149	Brake Disc Retainer Ring	---	1	---			---	24801	---	
624-151	Lower Hook with Latch (Includes Item 624-152)	1	1	28686	28687	28686	28687	35611	35611	35612
624-152	Latch Kit	1	1	45661	45662	45661	45662	45662	45662	45663
624-156	Load Chain (Specify Length)	1	1	85889 (Specify Length Required)			85979 (Specify Length Required)			
624-157	Lower Hook Assembly-Complete (Items 624-151 and 624-158)	1	1	---	28665	---	28665	---	---	35645
624-158	Lower Hook Collar (or Nut) Pin and Thrust Bearing	1	1	---	C325	---	C325	---	---	C326
624-159	Lower Sheave	1	1	---	27017	---	27017	---	---	35010
624-160	Lower Sheave Bearing	2	2	---	88429	---	88429	---	---	83674
624-161	Hook Block (*Must order in pairs with 624-162)	2	2	---	27048	---	27048	---	---	35034
624-162	Chain Stop Block	2		23465903C			23465603C			
624-163	Chain Stop Screw	2					982517			
624-164	Chain Stop Lockwasher	2					10095701			
624-165	Chain Stop Nut	2					982514			
624-166	Stop Block	1	1	24785			24786			
624-167	Alignment Pin	4	2	82354			82354			
624-170	Suspension Adapter	1	1	27703	27013	27703	27013	35740	35740	35741
624-171	Upper Hook with Latch (Includes Item 624-152)	1	1	28689	28697	28689	28697	35617	35617	35616
624-172	Upper Hook Collar (or Nut) and Pin	1	1	C329	C330	C329	C330	C331	C331	C332
624-173	Suspension Adapter Screw	2	2	987554			36849			
624-174	Rigid Hook Suspension-Complete	1	1	2788	2789	2788	2789	3651	3651	3658
624-175	Dead End Bolt	1	1	---	89508	---	89508	---	---	35957
624-176	Dead End Block, Pin, Washer and Cotter Pin	1	1	---	C334	---	C334	---	---	C335
624-177	Suspension Lug	1	1	27450	27452	27450	27452	35456	35456	35457
624-178	Lug Suspension - Complete			2778	2779	2778	2779	3677	3677	3668
624-179	Suspension Adapter Anchor	---	2	---			35066			
624-180	Back Frame Dowel	---	2	---			35768			
624-190	Brake Plate	1	1	24741			24740			
624-191	Brake Friction Plate	2	2	24603			24602			
624-192	Brake Field	1	1	24606			24608			
624-193	Brake Armature	1	1	24607			24609			
624-194	Brake Spring	2	2	24731			24732			
624-195	Brake Nut	2	2	982442			982443			
624-196	Brake Coil Retainer Strap	1	1	24738			24738			
624-197	Brake Disc	1 (Models WB, WE) 2 (Models WF, WH, WJ, WL, WR)		27817			24735			
624-198	Brake Friction Plate-Double (Not Required for Models WB, WE)	1	1	24600			24601			
624-199	Brake Coil	1	1	See Parts List on Page 22			See Parts List on Page 22			

PARTS LIST, continued

Key No.	Part Name	NUMBER REQUIRED		PART NUMBERS						
		Models WB, WE, WF, WH	Models WJ, WL, WR	Model WB	Model WE	Model WF	Model WH	Model WJ	Model WL	Model WR
624-200	Gear Housing Gasket	1	1	27747				35707		
624-210	Rotor Assembly (Items 624-108 and 624-112 included) (For 115-1-60 Units, Item 624-212 Included)	1	1	See Parts Lists on Page 22				See Parts List on Page 22		
624-211	Stator (Also order 624-113 for Models WB, WE, WF, WH)	1	1	See Parts List on Page 22				See Parts List on Page 22		
624-212	Centrifugal Mechanism and Spacer	1	---	C349				---		
624-213	Capacitor 115-1-60	1	1	27716				35278 Run Capacitor 35279 Start Capacitor		
624-214	Capacitor Mounting Clamp and Screw	1	1	C336				See Key No. 624-145		
624-215	Cut-out Switch with Attaching Screws 115-1-60	1	---	Order (1) Cut-Out Switch 24675 & (2) Screws 987523				---		
624-216	Contactors with Attaching Screw	1	1	Order (1) Contactor 28553, (2) Screws 957854 and (2) Lockwashers 957855				For 115-1-60 Units, Order (1) Contactor 35182, (2) Screws 957854 and (2) Lockwasher 957855. For 230/460-3-60 Units, Order (1) Contactor 24729, (2) Screws 957854 and (2) Lockwashers 957855		
624-218	Transformer with Attaching Screws	1	1	C343 (230/460 Units Only)				Order (1) Transformer 24900 & (2) screws 982683		
624-219	Wire Nuts (Specify Number Required)	---	---	982473 (Small) or 982477 (Large)				982473 (Small) or 982477 (Large)		
624-220	Jumper Set	1	1	For 115-1-60 Units, Order (1 Each) 51847, 24111, 24112 and 24113 Jumpers. For 230/460-3-60 Units, Order (1 Each) 24111, 24112, and 24113.				For 115-1-60 Units, Order (1) 51847, (1)51858, (1)51861 and Jumpers (3)27599 (1)24300, (1)24301, (1)24302 & (1)24303. For 230/460-3-60 Units, Order (1 each) 20331		
624-221	Power Cord 115-1-60 230/460-3-60	1	1	24106 24107				24119 24120		
624-230	Control Station and Cable 10 ft. Lift Units 15 ft. Lift Units 20 ft. Lift Units All Other Lifts	1	1	24100 24101 24102 Contact CM				24100 24101 24102 Contact CM		
624-231	Control Cable 10 ft. Lift Units 15 ft. Lift Units 20 ft. Lift Units All Other Lifts	1	1	24121 24122 24123 Contact CM				24121 24122 24123 Contact CM		
624-232	Control Station	1	1	See Figure 16, Page 22				See Figure 16, Page 22		
624-233	Warning Tag	1	1	81704				81704		
624-234	Product Label	1	1	24707				24707		
624-240	Rotor Wave Washer	1	---	27292				---		
624-241	Rotor Bearing Spacer	1	---	27291				---		
624-252	Warning Label (Electrical)	2	2	24842				24842		
624-760	Lower Hook and Block Assembly	1	1	28683	---	28683	---	35651	35651	---
624-763	Lower Hook Body	1	1	45401B	---	45401B	---	35370	35370	---
624-764	Lower Hook Chain Block Pin	1	1	45943	---	45943	---	35790	35790	---
624-771	Lower Hook with Latch	1	1	28686	---	28686	---	35611	35611	---
624-772	Lower Hook Thrust Bearing	1	1	88485	---	88485	---	88485	88485	---
624-774	Lower Hook Nut Pin	1	1	983772	---	983772	---	983772	983772	---
624-775	Lower Hook Chain Block	1	1	28007	---	28007	---	35026	35026	---
624-776	Lower Hook Nut	1	1	982526	---	982526	---	982526	982526	---
624-777	Lower Hook Block Washer	1	1	945921	---	945921	---	945921	945921	---
624-778	Solid State Reverse Switch	---	1	-----				35271		
624-779	Reverse Switch Clamp, Washer, Screw and Lockwasher	---	1	---				Order (1) 35267 Clamp, (1) 982210 Washer, (1) 983544 Lockwasher and (1) 987354 Screw		

PARTS LIST

MODELS AND VOLTAGES

Key No.	Part Name	No. Req'd	WB, WE		WF, WH		WJ		WL		WR	
			115-1-60	230/460	115-1-60	230/460	115-1-60	230/460	115-1-60	230/460	115-1-60	230/460
624-199	Brake Coil	1	51001	51003	51001	51003	---	51002	51001	51002	51001	51002
624-210	Rotor Assembly includes items 624-108 and 624-112 115-1-60 includes 624-212	1	24228	286004	24226	286000	---	---	---	---	---	---
624-211	Stator (also order 624-113 for models WB, WE, WF, WH)	1	24222	24221	24223	24220	---	24225	367001	24225	367001	24225

PACKAGED LUBRICANTS

Used in the Valustar Electric Chain Hoists
(Refer to page 12 for Lubrication Instructions)

Usage	Type	Quantity	Part No.
Hoist Gears	Grease (Special)	1/2# Can	28605
		1# Can	28616
		4# Can	28617
Spline on end of Drive Shafts	Oil-Graphite Mixture	1 Pint Can	40628
Load Chain	Oil	1 Pint Can	28608
		1 Gal. Can	28619

Lower Hook Thrust Bearing Grease: Heavy Cup Grease - obtain locally*

*These oils are not furnished by CM in packaged quantities.

When ordering lubricants, specify the type of lubricant, part number and packaged quantity required.

TOUCH-UP PAINTS

Valustar Electric Chain Hoists and Series 635 Low Headroom Trolleys

Name	Color	Quantity*	Size	Part No.
Hoist	Orange	1 case	12-12 oz. Aerosol Cans	84190
Trolley	Black	1 case	12-12 oz. Aerosol Cans	84189

*Touch-up paints are only available in case quantities.

NOTE: When painting Hoists or Trolleys, also order warning labels, identification labels, etc. that may be coated during painting.

CONTROL STATION

Key No.	Part Name	No. Req'd	Part No.
624-232	Control Station (Includes 624-301 thru 624-822)	1	36900B
624-252	Warning Label (Electrical)	1	24842
624-253	Manufacturer Label	1	28470
624-301	Control Station Grommet	1	36989
624-302	Control Station Housing	1	36998B
624-303	Gasket	1	36486
624-304	Control Station Button Assembly	1	36988
624-306	Control Station Parts Kit	1	36939
624-307	Contact Assembly (Includes 624-304)	1	36987
624-822	Warning Label	1	24845

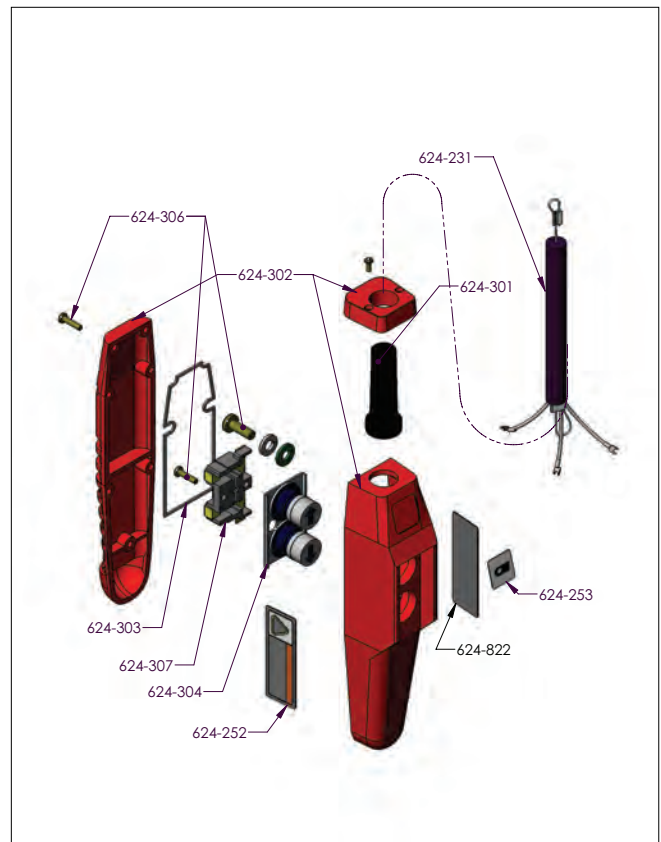

Figure 16. Control Station Exploded View

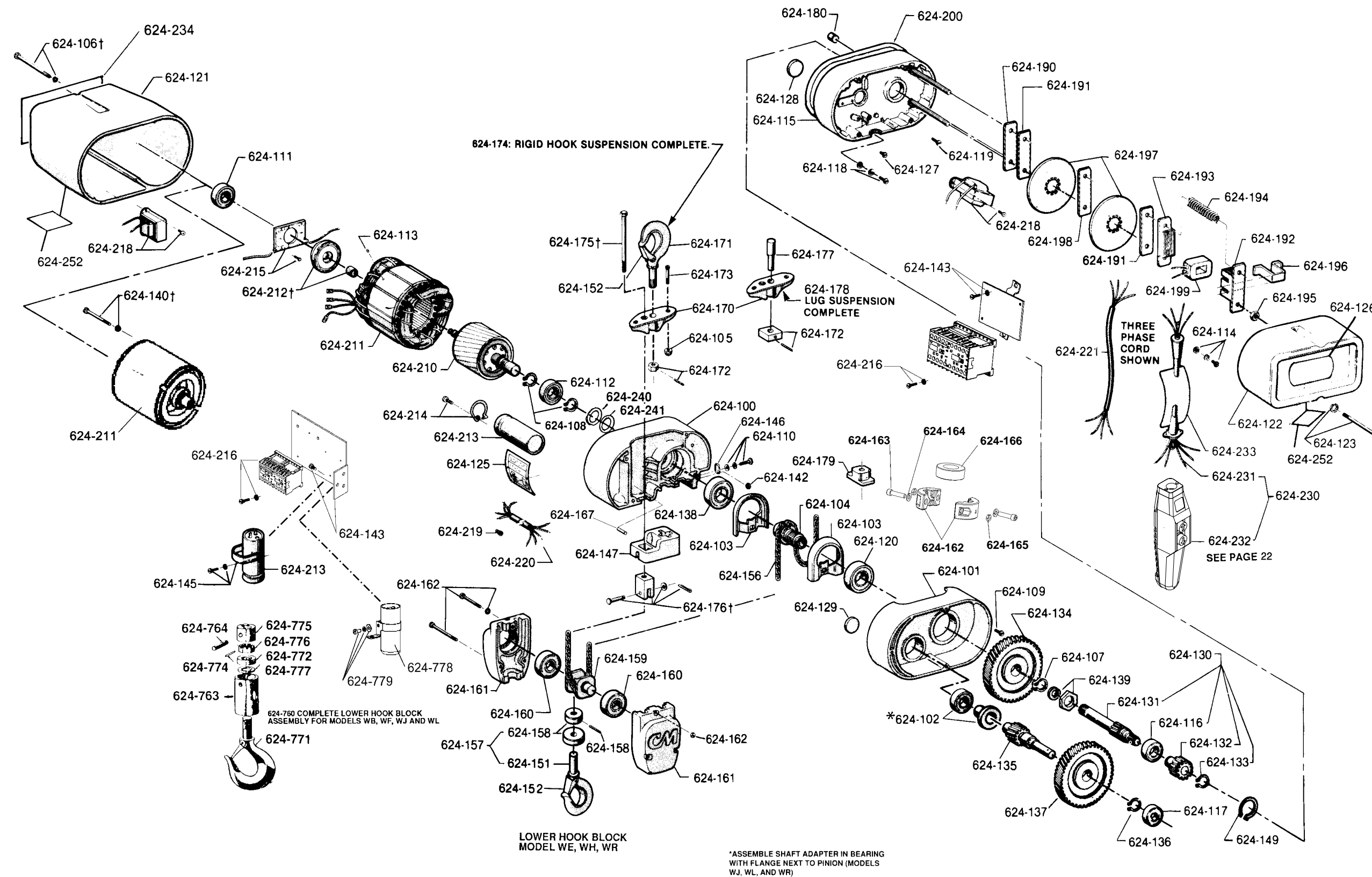

Figure 17. Valustar Electric Chain Hoist Exploded View

SERIES 635 LOW HEADROOM TROLLEY PARTS LIST

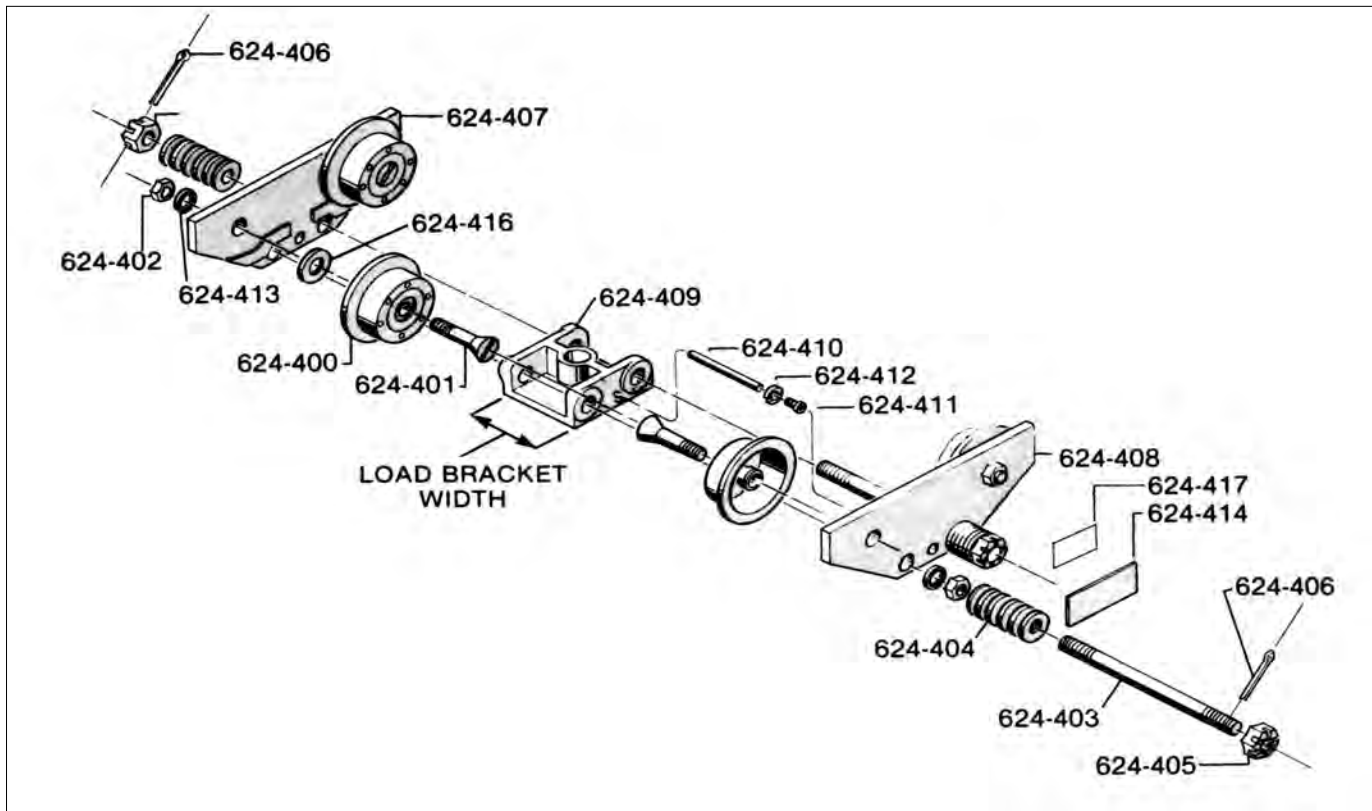

Figure 18. Series 635 Low Headroom Trolley Exploded View

Key No.	Part Name	No. Req'd.		Part No.		
		1-Ton	2-Ton	1-Ton	2-Ton	
624-400	Trackwheel	4	4	35774	50762	
624-401	Trackwheel Stud	4	4	987790	35838	
624-402	Trackwheel Stud Nut	4	4	982520	948804	
624-403	Suspension Bolt (Special Alloy Steel Bolt)					
		9-5/32" long*	2	-	35450	-
		10-1/4" long**	2	-	35407	-
		10" long†	-	2	-	35445
	12-1/16" long††	-	2	-	35414	
624-404	Trolley Spacer Washers					
		0.165" thick*	40	-	35782	-
		0.125" thick**	38	-	958822	-
		0.165" thick†	-	32	-	35783
	0.125" thick††	-	38	-	988039	
624-405	Suspension Bolt Nut	4	4	948803	958818	
624-406	Suspension Bolt Nut Cotter Pin	4	4	988343	988368	
624-407	Side Frame, Plain Side					
		Without Trolley Guards***	2	2	35640	35654
	Trolley Guards***	2	2	35635	35636	
624-408	Side Frame, ID Plate Side					
		Without Trolley Guards***	2	2	35640	35654
	Trolley Guards***	2	2	35635	35636	

Key No.	Part Name	No. Req'd.		Part No.		
		1-Ton	2-Ton	1-Ton	2-Ton	
624-409	Load Bracket					
		3-7/16" wide*	1	1	35019	-
		5-13/32" wide**	1	1	35024	-
		4-3/16" wide†	1	1	-	35033
	6-11/16" wide††	1	1	-	35043	
624-410	Vertical Load Bar Pin (Special Alloy Steel Pin)					
		2-11/16" long*	1	1	35371	-
		2-7/8" long**	1	1	-	35413
		3-3/4" long†	1	1	-	35400
624-411	Vertical Load Bar Pin Screw					
		1/2" long*	1	1	982383	-
		1-1/4" long**	1	1	982386	-
		3/4" long†	1	1	-	982433
	1-1/2" long††	1	1	-	987209	
624-412	Vertical Load Bar Pin Screw L.W.	1	1	983548	983547	
624-413	Trackwheel Stud Nut L.W.	4	4	987923	987924	
624-414	Identification Label	1	1	36916	36917	
624-416	Trackwheel Washer	-	1	-	987903	
624-417	Warning Label	1	1	936984	936984	

* These items are for the 1-Ton Trolley for operation on 2.66" thru 5.64" flange widths.
 ** These items are for the 1-Ton Trolley for operation on over 5.64" thru 7.00" flange widths.
 *** If side frame is equipped with spacer block, contact factory.

† These items are for the 2-Ton Trolley for operation on 3.33" thru 6.00" flange widths.
 †† These items are for the 2-Ton Trolley for operation on over 6.00" thru 8.25" flange widths.



Note: When ordering parts, always furnish hoist model and serial number, motor horsepower, voltage, phase, frequency and rated capacity of hoist on which the parts are to be used. For the location of the nearest CM Master Parts Depot, see the list located on the inside front cover.

LIMITATION OF WARRANTIES, REMEDIES AND DAMAGES

THE WARRANTY STATED BELOW IS GIVEN IN PLACE OF ALL OTHER WARRANTIES, EXPRESS OR IMPLIED, OF MERCHANTABILITY, FITNESS FOR A PARTICULAR PURPOSE, OR OTHERWISE, NO PROMISE OR AFFIRMATION OF FACT MADE BY ANY AGENT OR REPRESENTATIVE OF SELLER SHALL CONSTITUTE A WARRANTY BY SELLER OR GIVE RISE TO ANY LIABILITY OR OBLIGATION.

Seller warrants that on the date of delivery to carrier the goods are free from defects in workmanship and materials.

SELLER'S SOLE OBLIGATION IN THE EVENT OF BREACH OF WARRANTY OR CONTRACT OR FOR NEGLIGENCE OR OTHERWISE WITH RESPECT TO GOODS SOLD SHALL BE EXCLUSIVELY LIMITED TO REPAIR OR REPLACEMENT, F.O.B. SELLER'S POINT OF SHIPMENT, OF ANY PARTS WHICH SELLER DETERMINES TO HAVE BEEN DEFECTIVE or if Seller determines that such repair or replacement is not feasible, to a refund of the purchase price upon return of the goods to Seller.

Any action against Seller for breach of warranty, negligence or otherwise, must be commenced within one year after such cause of action occurs.

NO CLAIM AGAINST SELLER FOR ANY DEFECT IN THE GOODS SHALL BE VALID OR ENFORCEABLE UNLESS BUYER'S WRITTEN NOTICE THEREOF IS RECEIVED BY SELLER WITHIN ONE YEAR FROM THE DATE OF SHIPMENT.

Seller shall not be liable for any damage, injury or loss arising out of

the use of the goods if, prior to such damage, injury or loss, such goods are (1) damaged or misused following Seller's delivery to carrier; (2) not maintained, inspected, or used in compliance with applicable law and Seller's written instructions and recommendations; or (3) installed, repaired, altered or modified without compliance with such law, instructions or recommendations.

UNDER NO CIRCUMSTANCES SHALL SELLER BE LIABLE FOR INCIDENTAL OR CONSEQUENTIAL DAMAGES AS THOSE TERMS ARE DEFINED IN SECTION 2-715 OF THE UNIFORM COMMERCIAL CODE.

INDEMNIFICATION AND SAFE OPERATION

Buyer shall comply with and require its employees to comply with directions set forth in instructions and manuals furnished by Seller and shall use and require its employees to follow such instructions and manuals and to use reasonable care in the use and maintenance of the goods. Buyer shall not remove or permit anyone to remove any warning or instruction signs on the goods. In the event of personal injury or damage to property or business arising from the use of the goods, Buyer shall within 48 hours thereafter give Seller written notice of such injury or damage. Buyer shall cooperate with Seller in investigating any such injury or damage and in the defense of any claims arising therefrom.

If Buyer fails to comply with this section or if any injury or damage is caused, in whole or in part, by Buyer's failure to comply with applicable federal or state safety requirements, Buyer shall indemnify and hold Seller harmless against any claims, loss or expense for injury or damage arising from the use of the goods.



WARNING

Alterations or modifications of equipment and use of non-factory repair parts can lead to dangerous operation and injury.

TO AVOID INJURY:

- Do not alter or modify equipment.
- Do use only CM replacement parts.



Columbus McKinnon Corporation
Industrial Products Division
140 John James Audubon Parkway
Amherst, New York 14228-1197
1-800-888-0985
Fax 716-689-5644